

## I carrelli da reparto

The ward trolleys

Chariots pour services de soins

**preciso**



**francehospital®**

*trolleys for healthcare*

## Quando la creatività incontra l'innovazione

When creativity meets innovation

Preciso, créativité et innovation



### Precisione

Pareti laterali in alluminio estruso satinato o verniciato e parete posteriore in bicomponente di alluminio e polietilene si accoppiano perfettamente al piano di lavoro e alla base in PC/ABS\* ad iniezione, ottenendo una struttura assemblata leggera, robusta, di altissima qualità e precisione.

>>> Materiali preziosi, volumi misurati e linee essenziali.

### Precision

Lateral extruded aluminium sides either with brush finish or in enamel. Back wall made of an aluminium and Polyethylene multi-layer which perfectly adapts to the injection molded PC/ABS\* working surface and base. This results in a robust, lightweight, assembled structure of a remarkably high quality and precision.

>>> Precious materials, smooth volumes and essential lines.

### Conception

Les profilés en aluminium extrudé, les façades latérales en aluminium laqué époxy et la paroi arrière en alliage aluminium/polyéthylène, forment avec le plan de travail et la base en PC/ABS\* injecté, un ensemble léger et robuste de grande qualité.



### Creatività

Cassetti in PC/ABS\* ad iniezione, colore grigio-perla, in quattro altezze 76, 156, 256 e 316 mm, che possono essere utilizzati sia su guide-quadro a sfera, che direttamente sulle pareti ISO assieme a vaschette e cestelli ISO 600x400.

>>> Cassetti originali e compatibili con i sistemi ISO.

### Creativity

PC/ABS\* injection molded drawers in pearl-gray color, available in 4 heights: 76, 156, 256 e 316 mm (3, 6, 10, 12 inches), which can be used either on ball bearing square rails or directly on ISO-sides in combination with ISO trays 600x400 mm.

>>> Unique and versatile drawers, compatible with common ISO-systems.

### Modularité

Version tiroirs : Les tiroirs en PC/ABS\* injectés, interchangeables, existent en 4 hauteurs : 76, 156, 256 et 316 mm. Ils peuvent être montés sur glissières ou utilisés directement sur des parois ISO. Plusieurs modèles sont disponibles : différentes hauteurs de chariots et d'armoires en simple et double colonnes.

Version volet roulant : Structure équipée de parois internes pouvant accueillir les tiroirs, bacs et paniers au format ISO 600x400. Plusieurs modèles sont disponibles : différentes hauteurs de chariots et d'armoires en simple et double colonnes.



design by SALD / arch. Paolo Piuri

\* Il composto PC/ABS combina le migliori proprietà dei due materiali: le ottime qualità della plastica ABS e le superiori caratteristiche meccaniche e di resistenza al calore del policarbonato.

PC/ABS blend: A true industrial thermoplastic, this blend combines the most sought-after properties of both materials; excellent features of ABS and the superior mechanical properties and heat resistance of polycarbonate.

PC/ABS : techno polymère par excellence, ce composé allie les qualités techniques de l'ABS aux propriétés ignifuge et mécanique élevées du polycarbonate.



### Innovazione

Spazioso piano di lavoro - superficie equivalente ad un foglio DIN A2 - in PC/ABS\* ad iniezione, con tre bordi alti e bordino frontale antigocciolamento, perfezionato dall'innovativa maniglia di presa che corre su tre lati e funge anche da protezione contro urti e sfregamenti.

>>> Geometrie in perfetto accordo tra componenti e accessori.

### Innovation

Spacious working surface (equivalent to a DIN A2 sheet) made of PC/ABS\* injection mold, with three rims and a front lip with anti-dripping function. The working surface features an innovative handle on the lateral and back side which offers protection from impacts and frictions against obstacles or walls.

>>> Perfect geometrical harmony between components and accessories.

### Innovation

Plan de travail spacieux en PC/ABS injecté\* d'une superficie équivalente à une feuille A2. Il est équipé d'un rebord important sur trois côtés qui évite les chutes d'objets lors du déplacement du chariot. Un bord frontal antigouttes permet de contenir les liquides renversés. La poignée de préhension périphérique sert également de protection contre les chocs et les frottements.



### Fantasia

4 nuance di colore da combinare come si vuole: per identificare il reparto o la funzione, per abbinarsi all'arredo, per dare un certo tocco distintivo, o semplicemente per portare il buonumore!

>>> Tra le tonalità neutre come i grigi e il malva, spuntano le sfumature vivaci.

### Fantasy

Choice of 4 different colors that can be combined in many ways: to identify the function or the hospital department, to match existing furniture or wall colors, or just to simply add vivacity and bring a touch of color to the medical environment.

>>> Vivid nuances live up among natural tones like grays and mauve.

### Ligne et ergonomie













La ligne épurée de Preciso se concentre sur l'essentiel : la fonctionnalité et l'ergonomie. Une palette de quatre couleurs permet d'identifier le service et d'assortir nos chariots à l'environnement existant ou simplement de transmettre sa bonne humeur !

# Versatilità e Modularità













## Versatility and Modularity

### Modularité

Struttura in diverse altezze e configurazioni...  
Structure in different heights and configurations...  
Configurations standards...

<b>PRECISO</b>	H piano lavoro Working surface H Hauteur Plan de travail	LxP WxD Largeur x Profondeur	Cassetti su telaio montato su guide-quadro a sfera (configurazione standard) Drawers on frame mounted ball bearing square rails (standard configuration) Tiroirs sur cadres télescopiques (exemples de configurations)	Cassetti su parete ISO (configurazione standard) Drawers on ISO-sides (standard configuration) Tiroirs sur parois ISO (exemples de configurations)	Serranda Rolling shutter Volet roulant	Ante Doors Portes
<b>N°8</b>	920 mm - 36.3"	830x650 mm 33" x 25.5"	8 moduli / modules: 1x 76 mm - 3" 2x 156 mm - 6" 1x 236 mm - 9" 	8 moduli / modules: 1x 76 mm - 3" 2x 156 mm - 6" 1x 236 mm - 9" 	/	
<b>N°9</b>	1000 mm - 39.5"	830x650 mm 33" x 25.5"	9 moduli / modules: 3x 156 mm - 6" 1x 236 mm - 9" 	9 moduli / modules: 3x 156 mm - 6" 1x 236 mm - 9" 	/	
<b>N°10</b>	1080 mm - 42.6"	830x650 mm 33" x 25.5"	10 moduli / modules: 3x 76 mm - 3" 2x 156 mm - 6" 1x 236 mm - 9" 	10 moduli / modules: 3x 76 mm - 3" 2x 156 mm - 6" 1x 236 mm - 9" 	/	
<b>N°9-X</b>	1100 mm - 43.5"	830x650 mm 33" x 25.5"	9 moduli / modules: 3x 156 mm - 6" 1x 236 mm - 9" Cassetto laterale per computer Lateral computer drawer Tiroir latéral pour ordinateur portable 	9 moduli / modules: 3x 156 mm - 6" 1x 236 mm - 9" Cassetto laterale per computer Lateral computer drawer Tiroir latéral pour ordinateur portable 		/

... da combinare con i colori preferiti  
 ... to be combined with colors of preference  
 ... à combiner avec vos couleurs préférées

<p>Opzioni / Colore Options / Color Options / Couleur</p>	<p>Alluminio anodizzato Anodized Aluminium Aluminium anodisé</p>	<p>Blu-profondo Dark Blue Bleu</p>	<p>Rosso-rubino Ruby Red Rouge</p>	<p>Verde-mela Apple Green Vert</p>
		Pantone 286 C	Pantone 194 C	Pantone 390 C
<p>Angolari Corners Montants</p>				
<p>Pareti Walls Parois</p>				
<p>Angolari &amp; Pareti Corners &amp; Walls Montants et Parois</p>				

# Carrello Anestesia

## Anaesthesia Cart

### Chariot d'anesthésie

#### Struttura N° 9-X con cassetto laterale porta computer laptop

Colore alluminio Angolari blu-profondo  
 Piano scrittoio laterale  
 4 cassetti su guide-quadro a sfera o su parete ISO  
 Sopralzo con:  
 · Distributore siringhe/aghi su due file  
 · Porta flebo  
 2 cestelli in filo inox  
 Barra accessori con supporto scatole guanti

#### Structure N° 9-X with a lateral drawer for laptop computer

Basic Color: Aluminium – Corners in Dark-Blue  
 Lateral extractable writing surface  
 4 drawers on ball bearing square rails or on ISO-sides  
 Overbridge with:  
 · Syringe/needles dispenser on two rows  
 · IV holder  
 Two baskets in stainless steel wire mesh  
 Accessory rail with glove box holder

#### Structure N° 9-X avec tiroir latéral pour ordinateur portable

Coloris aluminium avec montants bleus  
 Verrouillage centralisé à clé ( option digicode )  
 Tablette écriteoire latérale étirable  
 4 tiroirs sur rails télescopiques ou sur parois ISO  
 Réhausse haute équipée de :  
 · Distributeur de seringues et d'aiguilles  
 · Support perfusion  
 2 paniers en fil inox amovibles  
 Rail avec support boîte à gants



**N° 9-X**  
 serranda e cassetto computer  
 rolling shutter and computer drawer  
 volet roulant et tiroir pour PC



**N° 9-X**  
 cassetti e cassetto computer  
 drawers and Computer drawer  
 tiroirs et tiroir pour PC



**N° 9-X**  
 senza cassetto computer  
 without computer drawer  
 volet roulant

**Cassetto porta computer** laptop a richiesta sul lato sinistro del carrello, montato su guide-quadro a sfera con rientro automatico; in lamiera verniciata, spazio utile 629x316x66,7 h mm.  
 Mousepad a richiesta.

Lateral computer drawer on request on the cart's left side, ball bearing square rails with self-closing mechanism; made of enameled laminated steel, suitable for laptops with a max. size of 629x316x66,7 h mm (24 3/4 x 12 1/2 x 2 1/2 ").  
 Mouse pad as an optional.

**Tiroir latéral pour ordinateur portable** avec système de sécurisation ( sur demande ) côté gauche du chariot, monté sur rails télescopiques à fermeture automatique. Le tiroir est en tôle acier laquée époxy et peut être équipé sur demande d'une tablette souris ( espace utile 629x316x66,7 h mm ).

# Carrello Medicazione

## Treatment Cart

### Chariot multifonctions

#### Struttura N° 9

Colore verde-mela Angolari alluminio

Piano scrittoio laterale

4 cassette su guide-quadro a sfera o su parete ISO

Chiusura centralizzata a chiave

Sopralzo alto con:

- Distributore siringhe/aghi
- Vassoio in plastica e distributore disinfettante
- Porta flebo
- Porta bacinella reniforme

Barra accessori con supporto scatola guanti e contenitore taglienti

Cestino rifiuti MAXIWALLY

#### Structure N° 9

Basic Color: Apple Green - Corners in Aluminium

Lateral extractable writing table

4 drawers on ball bearing square rails or on ISO-sides

Centralized lock with key

High overbridge with:

- Syringe/needles dispenser
- Plastic tray and disinfectant dispenser
- IV holder
- Kidney dish holder

Standard rail with glove box and sharp container  
MAXIWALLY waste bin

#### Structure N° 9

Coloris vert avec montants aluminium anodisé

Tablette écriteoire latérale étirable

4 tiroirs sur rails télescopiques ou sur parois ISO

Verrouillage centralisé à clé ( option digicode )

Réhausse haute équipée de :

- Distributeur de seringues et d'aiguilles
- Étagère ABS et distributeur de solution hydroalcoolique
- Porte sérum
- Support bassin réniforme

Porte boîte à gants et support collecteurs d'aiguilles

Collecteur de déchets MAXIWALLY



**N° 9**  
4 cassette  
4 drawers  
4 tiroirs



**N° 9**  
5 cassette  
5 drawers  
5 tiroirs



**N° 9**  
ante double door  
portes

**Chiusura centralizzata** a chiave dei cassetti, con chiave di sicurezza pieghevole.

A richiesta chiusura elettronica con pulsantiera incorporata al piano di lavoro. Programmabile con tre tipo di utente: Admin/Master/User.

**Centralized lock with key** for drawers, with hinged safety key.

On request: electronic lock with keypad integrated in the working surface. Programmable with three user codes: Admin/Master/User.

**Verrouillage centralisé** à clé pliable. Sur demande, fermeture électronique à digicode.

Programmable pour trois niveaux d'utilisateurs : Administrateur/Encadrement/Utilisateur.



# Carrello Chirurgico

## Surgical Cart

### Chariot multifonctions

#### Struttura N° 8

Colore rosso-rubino

Piano scrittoio laterale

4 cassetti su guide-quadro

a sfera o su parete ISO

Sopralzo basso con:

- Distributore siringhe/aghi
- 4 cassettoni con separatori regolabili e portaetichette

Barra accessori

#### Structure N° 8

Basic Color: Ruby Red –

Corners in Ruby Red

Lateral extractable writing table

4 drawers on ball bearing square

rails or on ISO-sides

Short overbridge with:

- Syringe/needles dispenser
- 4 supply bins with adjustable dividers and label holder

Standard accessory rail

#### Structure N. 8

Coloris rouge

Tablette écrivain latérale étirable

4 tiroirs sur rails télescopiques

ou sur parois ISO

Verrouillage centralisé à clé

( option digicode )

Réhausse basse équipée de :

- Distributeur de seringues ou aiguilles à un niveau
- 4 bacs tiroirs à accrocher avec séparateurs réglables et porte-étiquettes

Rail côté gauche

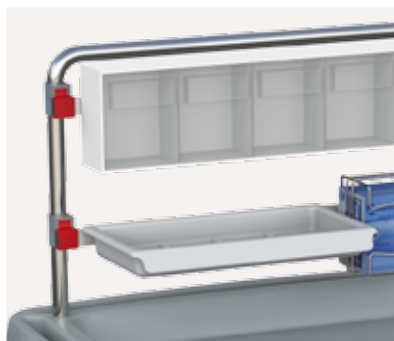

**N° 8**  
4 cassetti  
4 drawers  
4 tiroirs



**N° 8**  
4 cassetti h 156  
4 drawers h 156  
4 tiroirs h 156



**N° 8**  
ante  
double door  
portes

**Sopralzo:** disponibile in due altezze (500 e 800 mm dal piano lavoro) in tubo inox, montato all'interno della struttura, s'innesta sul piano di lavoro. Barre porta accessori in alluminio regolabili in altezza.

**Overbridge:** stainless steel tubular structure, available in 2 heights (500 e 800 mm - 19 3/4 and 31 1/2 inches from working surface), mounted on the cart's inner frame and integrated with the working surface. Equipped with height adjustable aluminium rails for accessories.

**Réhausse** en acier inoxydable : disponible en deux hauteurs ( 500 et 800 mm depuis le plan de travail ). Elle s'insère à l'intérieur de la structure et se fixe sur le plan de travail. Rails latéraux porte- accessoires en aluminium anodisé réglables en hauteur.





# Carrello Terapia

## Therapy Cart

### Chariot de soins

#### Struttura N° 9

Colore verde-mela  
 Piano scrittoio laterale  
 4 cassetti su guide-quadro a sfera o su parete ISO  
 Doppio cestino per rifiuti WALLY  
 Barra accessori con supporto scatola guanti e contenitore taglienti  
 Cestello in filo inox

#### Structure N° 9

Basic Color: Apple Green –  
 Corners in Apple Green  
 Extractable writing table on the side  
 4 drawers on ball bearing square rails or on ISO-sides  
 Double WALLY waste bin  
 Standard rail with glove box and sharps container  
 Basket: stainless steel wire mesh

#### Structure N° 9

Coloris vert  
 Tablette écrioite latérale étirable  
 4 tiroirs sur rails télescopiques ou sur parois ISO  
 Verrouillage centralisé à clé ( option digicode )  
 Rail avec 2 collecteurs à déchets WALLY  
 Rail équipé d'un support boîte à gants et support collecteur d'aiguilles  
 1 panier en fil inox amovible

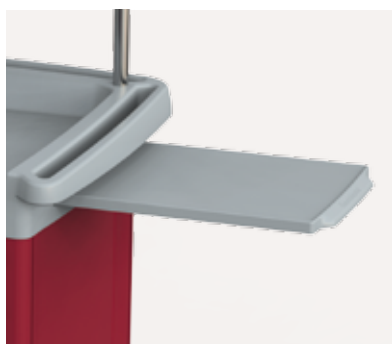

**N° 9**  
 4 cassetti  
 4 drawers  
 4 tiroirs



**N° 9**  
 5 cassetti  
 5 drawers  
 5 tiroirs



**N° 9**  
 ante  
 double door  
 portes

**Piano scrittoio** estraibile sul lato destro, estremamente robusto scorre su guide interne con un leggero fermo corsa sia in entrata che in uscita; spazioso come un foglio DIN A3, in plastica PC/ABS stampata ad iniezione.

Large lateral writing table large lateral writing table - equivalent to a DIN A3 size - in injection molded PC/ABS, on rails.

**Tablette** larérale étirable côté droit en PC/ABS injecté, extrêmement robuste, montée sur rails internes avec butée d'arrêt à l'ouverture et à la fermeture, de la surface d'une feuille format A3.



# Carrello Terapia infusione

## I.V. Therapy Cart Chariot de soins

### Struttura N° 9

Colore alluminio

Piano scrittoio laterale

4 cassette in plastica su guide-quadro a sfera o su pareti ISO

Asta porta flebo regolabile in altezza, con 2 ganci

Supporto scatola guanti e dispenser disinfettante

Barra accessori con cestelli portasacchetto

### Structure N° 9

Basic Color: Aluminium -

Corners in Aluminium

Extractable writing table on the side

4 drawers on ball bearing square rails or on ISO-sides

Adjustable IV pole, two hooks

Glove box and disinfectant dispenser holders

Accessory rail with waste bag holders

### Structure N° 9

Coloris aluminium

Tablette écrivain latérale étirable

4 tiroirs sur rails télescopiques ou sur parois ISO

Verrouillage centralisé à clé ( option digicode )

Potence porte-sérum réglable en hauteur, à deux crochets

Support boîte à gants et distributeur de solution hydroalcoolique

Rail latéral équipé de deux collecteurs à déchets



**N° 9**  
4 cassette  
4 drawers  
4 tiroirs



**N° 9**  
5 cassette  
5 drawers  
5 tiroirs



**N° 9**  
ante  
double door  
portes

**Barra accessori laterale** fissata con l'esclusivo sistema SABU® che consente di regolare l'altezza degli accessori in modo continuo, in qualsiasi momento.

Lateral accessory rail fixed with the exclusive SABU® system which allows adjusting the accessories' height at any time.

**Rail latéral porte-accessoires** équipé du système exclusif SABU® qui permet d'ajuster la hauteur des accessoires à tout moment.



# Carrello Isolamento

## Isolation Cart

## Chariot d'isolement

### Struttura N° 10

Colore alluminio Angolari verde-mela

Piano scrittoio laterale

6 cassetti su guide-quadro a sfera o su parete ISO

con tasselli colorati gialli per identificare il reparto

Asta porta flebo regolabile in altezza, con 2 ganci

Supporto scatola guanti e dispenser disinfettante

### Structure N° 10

Basic Color: Aluminium – Corners in Apple Green

Extractable writing table on the side

6 drawers on ball bearing square rails or on ISO-sides with yellow tabs identifying the ward

Adjustable IV pole, two hooks

Glove box and disinfectant dispenser holders

### Structure N° 10

Coloris aluminium avec montants verts

Tablette écriteoire latérale étirable

6 tiroirs sur rails télescopiques ou sur parois ISO

Verrouillage centralisé à clé ( option digicode )

Potence porte sérum réglable en hauteur, avec deux crochets

Support boîte à gants et distributeur de solution hydroalcoolique

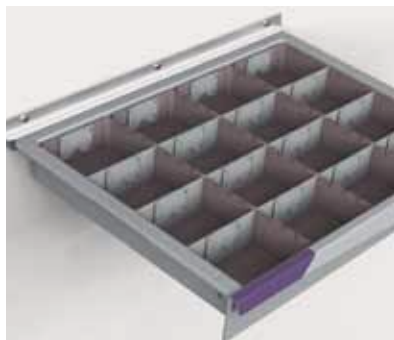

**N° 10**  
6 cassetti  
6 drawers  
6 tiroirs



**N° 10**  
5 cassetti  
5 drawers  
5 tiroirs



**N° 10**  
ante  
double door  
portes

I cassetti sono predisposti anche per l'aggancio su una speciale barra da fissare a parete: utilissima per l'uso del singolo cassetto presso il letto del paziente ed avere a portata di mano ciò che serve.

The drawers can also be used beside the patient bed simply by hanging the single drawer on a specific rail, to have the necessary supplies always within reach.

Les tiroirs sont également prévus pour être accrochés sur un rail normalisé externe : permet de fixer le tiroir près du lit du patient et de s'en servir comme plateau de travail.



# Carrello Rianimazione

## Critical Care Cart

### Chariot de réanimation

#### Struttura N° 9-X

con cassetto porta computer laptop  
 Colore rosso-rubino Angolari alluminio  
 Piano scrittoio laterale  
 Fronte chiuso con serranda:  
 • 2 cassetti h. 156 mm  
 • Vaschetta h. 100 mm  
 • Cestello h. 200 mm  
 Sopralzo basso con:  
 • Distributore siringhe/aghi  
 • Vassoi in plastica e supporto scatola guanti  
 Chiusura centralizzata digitale  
 2 cestelli in filo inox  
 Barra accessori con supporto contenitore taglienti  
 Porta cateteri

#### Structure N° 9-X

with laptop drawer  
 Basic Color: Ruby Red –  
 Corners in Aluminium  
 Extractable writing table on the side  
 Front closed with roll-up screen door:  
 • 2 drawers h. 156 mm  
 • ISO tray h. 100 mm  
 • ISO basket h. 200 mm  
 Centralized digital lock  
 Short overbridge with:  
 • Syringe/needles dispenser  
 • Plastic trays and glove box holder  
 2 baskets: stainless steel wire mesh  
 Accessory rail with waste bag holder  
 Catheter basket

#### Structure N° 9-X

avec tiroir ordinateur portable  
 Coloris rouge avec montants  
 en aluminium anodisé  
 Tablette écriteoire latérale étirable  
 Volet roulant de fermeture  
 Verrouillage centralisé  
 Aménagement intérieur :  
 • 2 tiroirs h. 156 mm  
 • Bac ISO h. 100 mm  
 • Panier ISO h. 200 mm  
 Réhausse basse équipée de :  
 • Distributeur de seringues ou d'aiguilles  
 • Étagère en ABS et support boîte à gants  
 2 paniers en fil inox amovibles  
 Porte sonde en inox



#### N° 9-X

serranda e cassetto computer  
 rolling shutter and computer drawer  
 volet roulant et tiroir pour PC



#### N° 9-X

cassetti e cassetto computer  
 drawers and Computer drawer  
 tiroirs et tiroir pour PC



#### N° 9-X

senza cassetto computer  
 without computer drawer  
 volet roulant

La **serranda** è flessibile, di colore malva, con movimento dal basso verso l'alto per evitare l'accumulo di polvere quando aperta; facilmente estraibile per la pulizia e per l'igienizzazione del carrello.

The mauve rolling shutter is flexible with upward opening to avoid dust accumulation. It is exceptionally easy to remove for cleaning and disinfection.

Le **volet roulant** est souple, de couleur mauve, fonctionne de bas en haut pour éviter le dépôt de poussière en position ouverte ; facilement démontable pour le nettoyage et la désinfection du chariot.

# Carrello Visita

## Patient Files Cart

### Chariot de visite

#### Struttura N° 9-X

Colore blu-profondo Angolari alluminio  
Piano scrittoio laterale

Fronte chiuso con serranda:

- Telaio sui guide per cartelle A4 dim. 330x250 mm o per radiografie dim. 465x390 mm
- 5 divisori verticali regolabili

Ruote gemellari Ø 125 mm,  
due con freno

#### Structure N° 9-X

Basic Color: Dark-Blue – Corners in Aluminium

Extractable writing table on the side

Front closed with rolling shutter

Inside:

- Rail holder frame for 4 charts dim. 330x250 mm or X-ray dim. 465x390 mm
- 5 adjustable vertical dividers

Twin wheels Ø 125 mm, two with brake

#### Structure N° 9-X

Coloris bleu avec montants en aluminium anodisé

Tablette écrivain latérale étirable

Volet roulant de fermeture

Verrouillage centralisé à clé

Aménagement interne :

- Cadre télescopique sur rails, porte dossier A4 dim. 330x250 mm ou pour radios dim. 465x390 mm
- Séparateurs verticaux réglables

Roues double galets Ø 125 mm,  
dont deux à freins



#### N° 9-X

serranda e cassetto computer  
rolling shutter and computer drawer  
volet roulant et tiroir pour PC



#### N° 9-X

cassetti e cassetto computer  
drawers and Computer drawer  
tiroirs et tiroirs pour PC



#### N° 9-X

senza cassetto computer  
without computer drawer  
volet roulant

Tutti i carrelli hanno di serie **4 ruote girevoli gemellari** Ø 125 mm, di cui 2 con freno con sistema "sblocco-facile"; ruote di altissima qualità, con doppio cuscinetto a sfera, igieniche grazie alla superficie liscia.

A richiesta: ruote singole, antistatiche e direzionali.

All the trolleys are equipped with swivelling Ø 125 mm twin wheels, 2 with brake with a special "kick pedal" unlocking system. Top level wheels on double ball bearing with flat surface for easy cleaning.

On demand: single wheels or antistatic or directional wheels.

Tous les chariots sont équipés en série de **4 roues double galets pivotantes** Ø 125 mm, dont deux avec le système de frein "blocage facile"; roue de très haute qualité, avec double roulements à billes, nettoyage aisé grâce à sa surface lisse.

Sur demande : roues simples, roues antistatiques et roues avec blocage directionnel.



# Carrello Logistica-Stoccaggio

## Logistics-Storage Cart

### Chariot logistique et stockage

#### Struttura N° 9-X

Colore alluminio

Piano scrittoio laterale

Chiusura a serranda

Pareti ISO per contenitori 600x400:

- 2 vaschette h. 50 mm
- 2 vaschette h. 100 mm
- 1 cestello h. 200 mm

#### Structure N° 9-X

Basic Color: Aluminium

Extractable writing table on the side

Front closed with roll-up screen door

ISO-sides for 600x400 ISO-trays/  
baskets:

- 3 trays h. 50 mm
- 2 trays h. 100 mm
- 1 basket h. 200 mm

#### Structure N° 9-X

Coloris aluminium

Tablette écrivain latérale étirable

Fermeture à volet roulant

Verrouillage centralisé à clé  
( option digicode )

Aménagement interne, parois ISO  
pour contenants 600x400 :

- 3 bacs h. 50 mm
- 2 bacs h. 100 mm
- 1 panier h. 200 mm

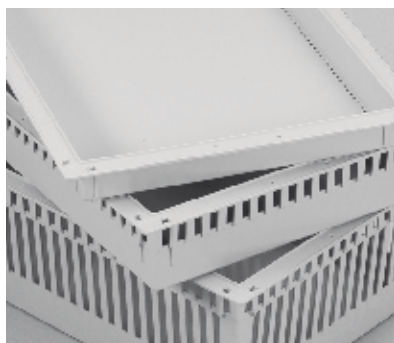

#### N° 9-X

serranda e cassetto computer  
rolling shutter and Computer drawer  
volet roulant et tiroir PC



#### N° 9-X

cassetti e cassetto computer  
drawers and Computer drawer  
tiroirs et tiroir PC



#### N° 9-X

senza cassetto computer  
without computer drawer  
volet roulant

I contenitori ISO 600x400, in plastica ABS, sono utilizzabili su parete ISO, ma anche su telaio con guide-quadro a sfera. In entrambi i casi sono chiudibili a chiave. Disponibili in diversi modelli.

ISO 600x400 trays/baskets in ABS plastic, to be used on ISO-sides but also on square rail frame instead of the drawers. In both cases they can be closed by key-lock.

Multiple models available.

Les contenants ISO 600x400, en ABS, sont utilisables sur parois ISO ou sur cadre monté sur rails télescopiques. Dans les deux cas ils peuvent être verrouillés .

Disponibles en plusieurs modèles de bacs et de paniers .



# Carrello Multiuso

## Multipurpose Cart

### Chariot à linge

#### Struttura N° 9

- Colore blu-profondo  
 Piano scrittoio laterale  
 Due ante in grigio-perla  
 Interno, pareti ISO con:
- Cassetto h. 76 mm
  - 2 ripiani lisci regolabili in altezza

#### Structure N° 9

- Basic Color: Dark Blue  
 Extractable writing table on the side  
 2 doors in pearl gray  
 Inside, ISO-sides with:
- 1 drawer h. 76 mm
  - 2 plain shelves, height adjustable

#### Structure N° 9

- Coloris bleu  
 Tablette écriteoire latérale étirable  
 Fermeture par deux portes grises  
 Aménagement interne, parois ISO avec:
- Tiroir h. 76 mm
  - 2 tablettes pleines réglables en hauteur
- Rail latéral porte-accessoires et panier en fil inox côté droit



**N° 8**  
 ante  
 double door  
 portes



**N° 9**  
 ante  
 double door  
 portes



**N° 10**  
 ante  
 double door  
 portes

La **chiusura con ante** è l'alternativa alla serranda. Le ante hanno interno schiumato che le rendono strutturalmente resistenti e leggere. Sono provviste di maniglie e chiusura a chiave. Cerniere in alluminio apertura a 180 °.

Door closing as an alternative to the rolling shutter. The doors' inner part is filled with foam, making them structurally resistant and lightweight. 180 ° opening with aluminium hinges, handles and key-lock.

La **fermeture avec portes** est l'alternativa au volet roulant. La structure interne des portes est en mousse expansée ce qui les rend résistantes et légères. Elles sont pourvues de poignées et d'une fermeture à clé. Charnières en aluminium, ouverture à 180 °.



# Carrello Distribuzione Farmaci

## Medication Distribution Cart

### Chariot de distribution de médicaments

#### Struttura N° 10 con cassettiere e cassettoni farmaci

Colore alluminio Angolari rosso-rubino

Piano scrittoio laterale

Fronte chiuso con serranda

- 1 cassetto h. 76 mm
- Cassetiera 4M con 6 cassettoni piccoli e 4 cassettoni grandi
- Cassetiera 5M con 24 cassettoni farmaci

Chiusura centralizzata digitale

Tube accessori con porta bicchieri e bottiglia

#### Structure N° 10 with Medicine-Bins and Bin-Cassettes

Basic Color: Aluminium – Corners in Ruby Red

Extractable writing table on the side

Front closed with roll-up screen door:

- 1 drawer h. 76 mm
- Bin-Cassette 4M with 6 small and 4 large Bins
- Bin-Cassette 5M with 24 Bins

Centralized digital lock

Accessory pole with cups dispenser and bottle holder

#### Structure N° 10 avec cassettes pour le transport des médicaments

Coloris aluminium avec montants de couleur rouge

Tablette écriteoire latérale étirable

Fermeture par volet roulant :

- 1 tiroir h. 76 mm
- Cassette 5 modules avec 24 petits bacs piluliers
- Cassette 4 modules avec 6 petits bacs piluliers et 4 grands bacs piluliers

Verrouillage centralisé à clé/digicode

Potence pour accessoires avec porte gobelets et porte bouteille



#### N° 9-X

2 cassettiere 4M-5M e cassetto PC / e serranda  
2 cassette-Bins 4M-5M and PC drawer / and rolling shutter  
2 cassettes et tiroir PC / et volet roulant



#### N° 9

2 cassettiere 4M-5M  
2 cassette-Bins 4M-5M  
2 cassettes 4M-5M



#### N° 10

2 cassettiere 4M  
2 cassette-Bins 4M  
2 cassettes 4M

La cassetiera porta cassettoni farmaci scorre su guide-quadro a sfera o su parete ISO. Facilmente estraibile è completa di maniglia e sportello frontale con chiusura a chiave per il trasporto.

Può contenere diversi modelli di cassettoni farmaci >>> vedi pag. 23 per ulteriori info.

The Bin-Cassette can be used on both ball bearing square rails or on ISO-sides. It is easy to remove and to transport. A key-lock and a label holder complete it.

The Bin-Cassette can accommodate the different models of Medicine-Bins >>> see page 23 for additional information.

Les cassettes pour le transport des médicaments sont en ABS injecté. Elles coulissent sur des rails télescopiques ou sur les parois ISO. Facilement extractibles, munies d'une poignée de préhension et d'un volet de fermeture frontal à clé.

Peut contenir les différents modèles de bacs piluliers >>> voir page 23 pour les informations complémentaires.





# Carrello Distribuzione Farmaci

## Medication Distribution Cart

### Chariot de distribution de médicaments

#### Struttura N° 9-X con cassetto porta computer e mousepad

Colore verde-mela Angolari alluminio

Piano scrittoio laterale

Chiusura a serranda

Pareti ISO con:

- 9 vassoi per cassettoni farmaci
- 54 cassettoni farmaci

Barra accessori laterale

#### Structure N° 9-X with lateral laptop drawer and mouse pad

Sides: Apple Green – Corners in Aluminium

Extractable writing table on the side

Front closed with roll-up screen door

ISO-sides with:

- 9 plastic Bin-Trays
- 54 Medicine-Bins

Lateral accessory rail

#### Structure N° 9-X avec tiroir latéral pour ordinateur portable et tablette souris

Coloris vert avec montants en aluminium anodisé

Tablette écriteoire latérale étirable

Fermeture à volet roulant

Verrouillage centralisé à clé ( option digicode )

Parois interne ISO avec :

- 9 plateaux en ABS thermoformé pour bacs piluliers
- 54 bacs piluliers

Rail latéral côté droit

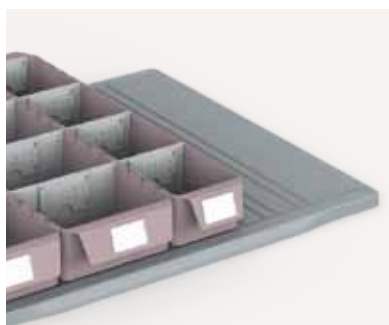

#### N° 9-X

con cassetto computer  
with computer drawer  
volet de fermeture et tiroir PC



#### N° 9-X

senza cassetto computer  
without computer drawer  
volet roulant



#### N° 9

ante  
double door  
tiroirs

Il vassoio è in plastica stampata con nervature per il corretto alloggiamento dei cassettoni farmaci in diverse misure. Utilizzabile su pareti ISO.

>>> vedi pag. 23 per ulteriori info

The Bin-Tray is in light-gray molded plastic, specifically designed to accommodate the different versions of Medicine-bins. It can be used with ISO-sides.

>>> see page 23 for additional information.

Le plateau en ABS thermoformé reçoit les bacs piluliers de tailles diverses. Utilisable sur parois ISO ou sur rails télescopiques.

>>> voir page 23 pour les informations complémentaires

# Flessibilità e Configurabilità

Flexible & Customizable  
Configuration des tiroirs



## I cassetti

I cassetti PRECISO in plastica PC/ABS stampata ad iniezione, di colore grigio-perla, hanno la maniglia di presa dalla linea morbida, incorporata al frontalino.

Tutti gli angoli sono arrotondati e le superfici lisce per la facile pulizia.

### Sul frontalino sono presenti:

- Largo porta etichette con protezione in plastica trasparente
- Tassello colorato intercambiabile per l'identificazione del contenuto, disponibile in nove colori:

## The Drawers

PRECISO Drawers are made of PC/ABS injection mold in pearl-gray color, with rounded edges and handles integrated in the front for gripping.

All sharp edges or corners are rounded and all surfaces smoothed for easy cleaning.

### On the front there is:

- Wide label holder, plastic protected
- Interchangeable colored tag for fast identification of contents, available in nine colors:

## Les tiroirs

Les tiroirs PRECISO en PC/ABS injecté, de couleur gris perle, sont munis d'une poignée aux lignes courbes en façade.

### Repères en façade :

- Les façade sont équipées d'un large porte-étiquette et d'une réglette de couleur interchangeable pour l'identification du contenu du tiroir.
- Coloris disponibles :



I cassetti PRECISO sono utilizzabili sia su guide-quadro a sfera, che direttamente sulle pareti ISO.

Un originale telaio color malva incorpora le guide, ed è la sede sia di cassetti che di vaschette e cestelli ISO; in questo modo i cassetti sono facilissimi da estrarre per la pulizia e da intercambiare.

Le guide-quadro a sfera sono silenziose, telescopiche, ad estrazione totale, antiribaltamento, con rientro automatico e ammortizzatore ad aria.

Il cassetto a 4 moduli h. 316 mm ha il frontale in plastica e la struttura in acciaio con supporto per le cartelle.

PRECISO Drawers can be used either on ball bearing square rails or directly on ISO-sides. An original frame, mauve coloured, integrates the guide rails, and is compatible with drawers, ISO-trays/-baskets. In this way the drawers are easy to remove for cleaning and easy to change with ISO-trays/-baskets. Ball bearing telescopic square rails are completely extractable, silent, with anti-tilting features and self-closing mechanism with air shock absorbers.

The drawer 4 modules h. 316 mm (12 inches) has a plastic front part and a laminated steel structure with special rail system for hanging patients files.

Les tiroirs PRECISO peuvent être utilisés sur cadres télescopiques ou directement sur des parois ISO.

Le tiroir h. 316 mm ( façade ABS et structure acier laqué époxy ) est équipé d'un support à dossiers suspendus format A4.

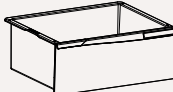
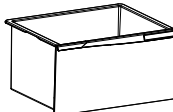

**Dati tecnici cassetti / Technical data for drawers / Données techniques tiroirs**

<b>Moduli Modules</b>	<b>Altezza Height Hauteur</b>	<b>Larghezza Width Largeur</b>	<b>Profondità Depth Profondeur</b>	<b>Volume (L - ft³) Volume (L - ft³) Capacité ( L - ft³ )</b>
1 	76 mm - 3" (int. 67 mm)	610 mm - 24" (int. 540 mm)	470 mm - 18" (int. 410 mm)	151 - 495.41
2 	156 mm - 6" (int. 146 mm)	610 mm - 24" (int. 540 mm)	470 mm - 18" (int. 410 mm)	325 - 1066.27
3 	236 mm - 9" (int. 225 mm)	610 mm - 24" (int. 540 mm)	470 mm - 18" (int. 410 mm)	497 - 1630.58
4 	316 mm - 12"	610 mm - 24" (int 555 mm)	470 mm - 18" (int 400 mm)	67 - 2.36

**Portata:** 40 kg su guide, 10 kg su parete ISO  
**Capacity:** 40 kg on rails, 10 kg on ISO-walls  
**Capacité :** 40 kg sur rails, 10 kg sur parois ISO

# L'organizzazione dei cassetti

## Drawer organization

## L'organisation des tiroirs



Vaschette in plastica ABS colore malva, stampate ad iniezione, disponibili in: due larghezze, due altezze e due lunghezze (26 e 40 cm) consentono oltre una dozzina di combinazioni per organizzare il contenuto dei cassetti in maniera ottimale ed efficiente.

Drawer-bins in injection molded ABS plastic are mauve colored and available in two widths, two heights and two lengths (26 and 40 cm – 7 ¾ and 15 ¾ inches). They can be arranged in more than a dozen combinations to organize the content in a personalized and efficient manner.

Bacs tiroirs en ABS injecté de couleur mauve, disponibles en deux largeurs, deux hauteurs et deux longueurs ( 20 et 40 cm ) permettant plus d'une douzaine de combinaisons pour organiser le contenu des tiroirs de manière optimale et efficace.

Le vaschette sono provviste di divisori regolabili e di originali porta etichette regolabili:

Drawer-bins come with adjustable dividers and label holders:

Séparateurs et porte-étiquettes:

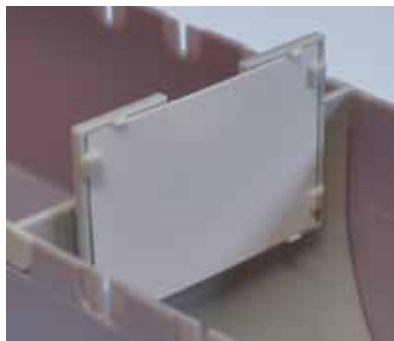

Mod. ET

Lungh. 400 mm/Completa di 3 divisori e 4 porta etichette  
Length 400 mm/Complete with 3 dividers and 4 label holders  
Longueur 400 mm/Avec 3 séparateurs et 4 porte-étiquettes

V6-1M	403x82x58 mm	
VSC6-1M	vaschetta / bin / bac	
DIV6-1M	divisorio / divider / séparateur	
V6-2M	400x80x138 mm	
VSC6-2M	vaschetta / bin / bac	
DIV6-2M	divisorio / divider / séparateur	
V4-1M	403x125x58 mm	
VSC4-1M	vaschetta / bin / bac	
DIV4-1M	divisorio / divider / séparateur	
V4-2M	400x125x138 mm	
VSC4-2M	vaschetta / bin / bac	
DIV4-2M	divisorio / divider / séparateur	

Lungh. 260 mm/Completa di 2 divisori e 3 porta etichette  
Length 260 mm/Complete with 2 dividers and 3 label holders  
Longueur 260 mm/Avec 3 séparateurs et 4 porte-étiquettes

V42-1M	264x125x58 mm	
VSC42-1M	vaschetta / bin / bac	
DIV4-1M	divisorio / divider / séparateur	
V42-2M	261x125x138 mm	
VSC42-2M	vaschetta / bin / bac	
DIV4-2M	divisorio / divider / séparateur	

# Kit vaschette per cassette

Drawer-bin kits

Kit bacs tiroirs

Cassetto / Drawer / Tiroir h 76 mm (Mod. xxx-1M) Cassetto / Drawer / Tiroir h ≥156 mm (Mod. xxx-2M)						
Mod.	K6V6-1M / -2M	K4V4-1M / -2M	K6V42-1M / -2M	K3V422V4-1M / -2M	K3V62V4-1M / -2M	K3V63V42-1M / -2M
Incl. porta etichette e divisori / Incl. label holders and dividers / Avec porte étiquettes et séparateurs						
Var 1						
Var 2						
Var 3						

# Configurazioni pareti ISO 600x400

## ISO 600x400 Configurations

### Configurations sur parois ISO 600x400

- >>> Molteplici accessori per organizzare il carrello ed esaudire ogni specifica esigenza.
- >>> Multiple accessories are available to organize the trolleys efficiently to meet every need.
- >>> Multiples accessoires pour organiser le chariot et répondre à chaque exigence spécifique.



**Cassetti** 76 mm (1 modulo) - 156 mm (2 moduli) - 236 mm (3 moduli)  
**Drawers** 76 mm (1 module) - 156 mm (2 modules) - 236 mm (3 modules)  
**Tiroirs** 76 mm (1 module) - 156 mm (2 modules) - 236 mm (3 modules)

Mod. CP-1M / CP-2M / CP-3M



**Vaschette e cestelli ISO**  
 600x400x h 50 mm - 100 mm - 200 mm  
**ISO-trays and -baskets**  
 600x400x h 50 mm - 100 mm - 200 mm  
**Bacs et paniers ISO 600x400**  
 50 mm - 100 mm - 200 mm

Mod. VP050/100/200 - CP100/200



**Separatori verticali** porta cartelle  
 Vertical dividers for patient files  
**Séparateurs verticaux** pour dossiers patients

Mod. PRE-SV



**Cassettiere** per cassettoni farmaci  
 Bin-Cassettes for Medicine-Bins  
**Cassettes** pour le transport des médicaments

Mod. CA-3M / CA-4M / CA-5M



Mod. PRE-R



Mod. VP-CM & UD-CM



Mod. PRE-TEC



Mod. VA-BIN & BIN

**Ripiani** interni regolabili  
 Internal height adjustable shelves  
**Etagère** interne

**Dispenser farmaci** con coperchio su vassoio  
 Medicine dispensers on a tray for daily therapy  
**Plateau pour dispensation** journalière des médicaments

**Telai** su guide per cartelle A4 dim. 330x250 e radiografie dim. 465x390 mm  
 Framed patient file holder for patient charts A4 dim. 330x250 mm or X-ray dim. 465x390 mm  
**Cadre télescopique** porte-dossiers format A4 ou radio

**Vassoi** per 4-6 cassettoni farmaci  
 Bin-Trays for Medicine-Bins (4 to 6 for each tray)  
**Plateau pour bacs piluliers** (4-6 par plateaux)

# Cassettini farmaci, cassettiere e vassoi

## Medicine-Bins, Cassettes and Trays

### Cassettes pour le transport des médicaments

Innovativi cassetini farmaci in plastica ABS ad iniezione, colore malva, disponibili in:

- Due larghezze 12,5 e 8 cm,
- Due altezze 5,8 e 13,8 cm

Permettono di organizzare la distribuzione dei farmaci e della terapia giornaliera in dose unitaria.

Sul lato frontale hanno maniglia di presa con porta etichette, sul retro un sistema di aggancio alla barra porta accessori per poter essere utilizzati anche sul sopralzo dei carrelli.

I cassetini farmaci vengono impiegati su vassoi o su specifiche cassettiere modulari disponibili in 3 versioni (3, 4 e 5 moduli). Le cassettiere – adoperate su guide-quadro a sfera o su parete ISO – sono in plastica ABS complete di maniglia e di sportello con chiusura a chiave per il trasporto.

Innovative Medicine-Bins in injection molded mauve ABS for medication distribution. Available in:

- Two widths 12,5 and 8 cm
- Two heights 5,8 and 13,8 cm

They allow organizing the daily unit-dose therapy distribution at the patient bed in the best way.

Front side: handle with label holder  
Back side: hook to fix it on the accessory rail.

The Medicine-Bins can be carried on Bin-Trays or on specific Bin-Cassettes.

The Bin-Cassettes are modular and available in 3 versions (3, 4 and 5 modules) and are made of injection molded ABS. Suitable for the easy transport to/from the pharmacy and to/from the ward thanks to the top handle, the label holder and the key-lock closing flap.

Les bacs piluliers pour la distribution des médicaments sont en ABS injecté, de couleur mauve, disponibles en :

- Deux largeurs 12,5 et 8 cm,
- Deux hauteur 5,8 et 13,8 cm

Ils permettent d'organiser la distribution journalière des médicaments en doses unitaires.

Ils sont munis sur l'avant d'une poignée de saisie avec porte étiquette, et sur l'arrière d'un système d'accroche sur rail normalisé qui peut être également utilisé sur la réhausse du chariot.

Les cassettes de transport qui accueillent les bacs piluliers sont en ABS injectés. Elles sont modulaires et existent en plusieurs capacités ( encombrement 3,4 ou 5 modules ). Equipés d'un volet frontal de fermeture, d'un porte étiquette et d'une poignée de préhension, elles permettent des échanges efficaces entre pharmacie et services de soins.



I cassetini farmaci sono completi di divisori regolabili e di originali porta etichette mod. ET.

The Medicine-Bin features internal dividers and specific label holders with a unique design mod. ET.

Les bacs piluliers peuvent être équipés de séparateurs réglables et de porte étiquettes mod. ET.



Mod. 4M chiuso / closed / fermé



Mod. 4M



Mod. 5M

Lungh. 400 mm (spazio utile)/Completo di 3 divisori e 4 porta etichette		
Length 400 mm (usable space)/Complete with 3 dividers and 4 label holders		
Longueur. 400 mm ( espace utile )/Avec 3 séparateurs et 4 porte-étiquettes		
BIN6-1M	403x82x58 mm	
VSC6M-1M	cassetino / bin / bac	
DIV6-1M	divisorio / divider / séparateur	
BIN6-2M	400x80x138 mm	
VSC6M-2M	cassetino / bin / bac	
DIV6-2M	divisorio / divider / séparateur	
BIN4-1M	403x125x58 mm	
VSC4M-1M	cassetino / bin / bac	
DIV4-1M	divisorio / divider / séparateur	
BIN4-2M	400x125x138 mm	
VSC4M-2M	cassetino / bin / bac	
DIV4-2M	divisorio / divider / séparateur	

## Accessori vari per la struttura e il sopralzo

Various accessories for the Basic Structure and the Overbridge

Accessoires pour le chariot et la réhausse

Alcuni dei molti accessori per completare l'allestimento del carrello:

A selection of the available accessories:

Accessoires divers pour compléter l'aménagement du chariot :

**Accessori generali**  
**General Accessories**  
**Accessoires généraux**



Mod. CA

Cavo antifurto per laptop  
Laptop security lock  
Cadenas pour sécuriser le PC



Mod. APF-PR

Asta flebo  
I.V. pole  
Potence porte sérum



Mod. CLCS

Porta cateteri inox  
Stainless steel catheter basket  
Porte-sondes inox



Mod. CLT

Cestello in filo di acciaio  
Basket in stainless steel wire mesh  
Panier fil en acier inoxydable amovibile



Mod. APVD

Tubo porta accessori  
Tubular accessory holder  
Potence porte-accessoires



Mod. PR-TD

Barra laterale  
Lateral accessory rail  
Rail latéral



Mod. PCVSPCA

Porta cartelle A4 removibile  
Removable A4 charts holder  
Porte dossiers A4 amovible



Mod. MWAL

MAXIWALLY cestino rifiuti grande  
MAXIWALLY trash bin – large size  
Collecteur de déchets MAXIWALLY

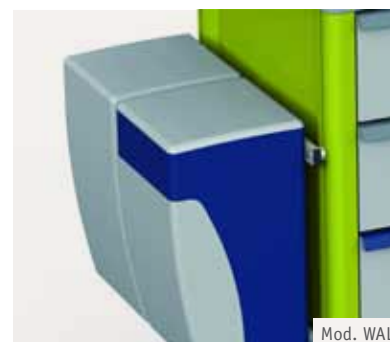

Mod. WAL

WALLY cestino rifiuti piccolo  
WALLY trash bin – small size  
Collecteur de déchets WALLY



Mod. PH2-PH4

Porta sacco rifiuti  
Trash bag holder  
Collecteurs à déchets



**Per soprazzo**  
**For the Overbridge**  
**Pour réhausse**



Mod. PCMBC54  
 Distributore siringhe/ago  
 Syringe/needles dispenser  
 Distributeur de seringues et d'aiguilles

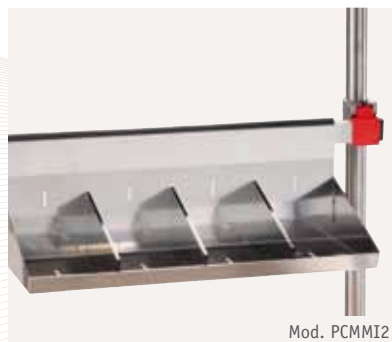

Mod. PCMM12  
 Mensola inox  
 Stainless steel tray  
 Etagère en acier inoxydable



Mod. VA  
 Mensola in plastica larga  
 Plastic tray – large size  
 Grande étagère en ABS



Mod. VA-D  
 Mensola in plastica  
 Plastic Tray  
 Etagère en ABS

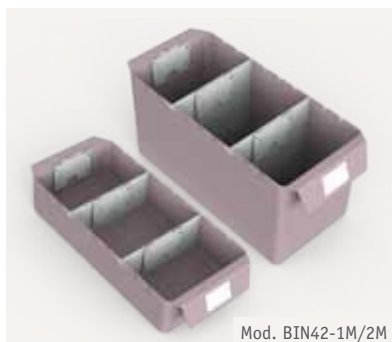

Mod. BIN42-1M/2M  
 Casettini  
 Supply bins  
 Bacs-tiroirs à accrocher



Mod. SPG-T2/T3  
 Porta scatola guanti (1 e 3 scatole)  
 Glove box holder (for 1 or 3 glove boxes)  
 Support boîtes à gants (1 ou 3 boîtes)



Mod. PCMF  
 Gancio flebo  
 I.V. hook  
 Crochet porte-sérum



Mod. PCMA  
 Supporto bacinella reniforme  
 Kidney dish holder  
 Support bassin réniforme



Mod. PCMVD  
 Vaschetta disinfezione strumenti  
 Instrument disinfectant basin  
 Bac à désinfection



Mod. PCMDS  
 Dispenser disinfettante  
 Disinfectant dispenser  
 Distributeur de solution hydroalcoolique



Mod. PCMPBC  
 Distributore bicchieri  
 Plastic glass dispenser  
 Distributeur de gobelets



Mod. SUPUN  
 Supporto contenitore taglienti  
 Sharps container holder  
 Support collecteur d'aiguilles

**Per i reparti pediatrici**  
**For paediatric wards**  
**Pour la pédiatrie**



Mod. GP  
 Grafica in diverse fantasie  
 Multiple fantasy graphics  
 Différents graphismes disponibles





**Quando la precisione incontra la logica**  
When precision meets the logic  
Gamme élargie pour solutions logistiques

Richiedi il catalogo di PRECISO dedicato alla logistica.  
Request the PRECISO catalogue for logistics.  
Demander le catalogue PRECISO solutions logistiques.

[preciso@francehopital.com](mailto:preciso@francehopital.com)

**FRANCEHOPITAL S.A.S.**

Z.I. Ouest Rue Georges Besse  
B.P. 50030

F-67151 ERSTEIN Cedex / FRANCE

Tél. +33 03 88 59 87 87

Fax +33 03 88 98 04 44

[francehopital@francehopital.fr](mailto:francehopital@francehopital.fr)

Export Office / Ufficio Commerciale Italia  
via Bolzano, 2

I-39011 Lana / BOLZANO - ITALY

Tel. +39 0473 55 26 11

Fax +39 0473 55 26 99

[export@francehopital.com](mailto:export@francehopital.com)

© PRECISO is a registered name

Ci riserviamo di apportare le opportune modifiche tecniche e/o estetiche ai prodotti, senza alcun preavviso.

We reserve the right to change our products and their specifications at all times for technical or esthetical reasons, without prior notice and without obligation to report the change.

Nous nous réservons le droit de modifier sans préavis nos produits et leurs spécifications à tout moment, pour des raisons techniques ou esthétiques, sans obligation de mentionner ces changements.

[www.francehopital.com](http://www.francehopital.com)  
[www.francehopital.fr](http://www.francehopital.fr)

**francehopital**<sup>®</sup>  
trolleys for healthcare