

Our expertise - your gain



www.rcn-medizin.com

Contents

Why RCN?	4
Shower Stools	6
Toilet Raisers	10
XXXL-Shower Stools	11
Shower- /Commode Chairs, Series 200	12
Multi-Purpose Shower- /Commode Chairs, Series 250	14
Travel Chairs	25
XXL Multi-Purpose Shower- /Commode Chairs	26
XXXL Multi-Purpose Shower- /Commode Chairs	32
Shower- and Transfer Wheelchairs	34
Tilt Shower- /Commode- /Care Chair, Comfort E	36
Shower- /Transfer Gurneys	38
Walkers and Combo Walker	46
Linen Hampers and Waste Collectors	53
Station Carts	56
Multi-Purpose- and Specialty Carts	61
Linen Carts, Clothes- and Laundry Carts	62
Documentation Carts /Chart Carts	64
MRSA / Hygiene Station Carts	66
Gel Seat-Cushions	70
Beach Mobil	71
MRI Compatible Products	72
Mobile Privacy Screens	75
Recliner Chair	75
Easy Lift LS 2000	76
Technical Data	78

Why RCN?

Whatever you are looking for, Multi-Purpose Shower- / Commode Chairs, Shower Stools, Walkers, Bariatric Equipment, Shower Gurneys, Linen Carts, Multi-Purpose Carts, Hampers or Equipment for the MRI Center - RCN offers a broad selection for the healthcare environment.

RCN products are made, using a modular system of high quality, very high impact plastic components. They allow manufacturing of Bariatric XXXL Equipment with load factors reaching 400kg.

A vast variety of options, fabrics and colors allows you to select a product that truly fits the needs of the user.

Functionality and attention to detail together with outstanding longevity, sturdiness and ease of handling as well as lightweight and great mobility are but a few of the qualities that put products made by RCN into a league of its own.

- Absolutely no rusting parts
- Adaptable to individual needs
- Economical custom solutions
- 3 year warranty
- 5 year warranty on RCN customary plastic frames

Our team of product specialists will gladly assist you in selecting the right product or the right market approach for you, all you need to do is get in touch with us.



You should not accept anything less!

Because expertise and quality count!



RCN products ...

- Are field tested by healthcare professionals
- Require very little maintenance
- Can be economically adapted to individual requirements
- Are tested by the TÜVlab
- Offer exceptional longevity

Our promise to you:

- Short delivery times
- Specific product solutions
- Great customer service
- Lowest cost of ownership

Shower Stools for the safety conscious

What should a quality Shower Stool offer?

It has to be safe, comfortable, lightweight, hygienic and absolutely non-rusting or corroding!

All RCN Shower Stools are built according to these requirements that health professionals and our customers demand.

- Sturdy and stable
- Easy to clean
- Special anti-slip legs
- UV-resistant and compatible with most disinfectants
- Frame made of RCN proprietary high impact plastic
- 3 year warranty
- 5 year warranty on frame

DH 49

A classic among Shower Stools! Sturdiness and comfort at an affordable cost. Lightweight, yet supports up to 200 kg. Its ergonomically designed seat - with central hygiene opening - is comfortable and offers ample access.

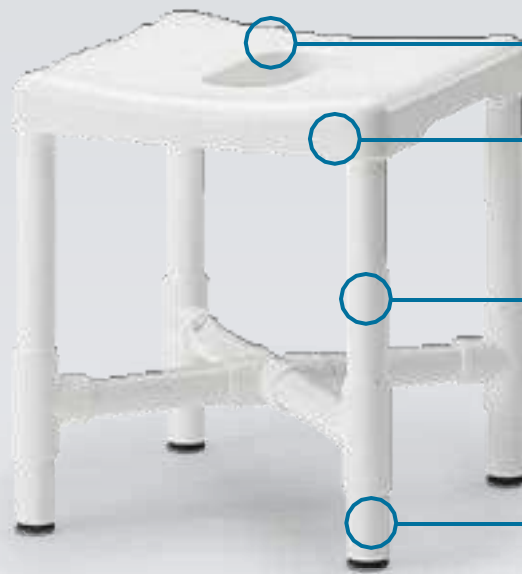

Central hygiene opening

Ergonomically designed seat

Frame made of RCN high impact plastic components supports up to 200 kg

4 anti-slip legs

Options for more comfort:



A
Armrest

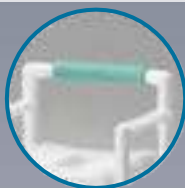

RL
Padded backrest, available in 4 colors



PRS
Soft backrest only in blue



HV
Height adjustment to 7 different levels

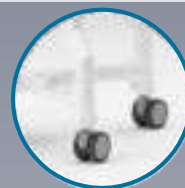

DLR
Ø 75 mm NO RUST twin-wheel swivel casters - all locking



PA
Nesting seat pad, available in 4 colors

DH 49 A PA Supports up to 150kg



DH 49 HV

Supports up to 150 kg



Shower Stool DH 49 and its variants

DH 49 A



DH 49 ARL



DH 49 A RL PA



DH 49 PRS



DH 49 A PRS



DH 49 PRS PA



All models shown on this page support a load factor of up to 150 kg and are guaranteed not to rust or corrode. The seat height can be made to fit the individual need for no additional cost. For color selection turn to pages 78 and 79

DH 49 DLR

Shower Stool with wheels, frame extended for additional safety.

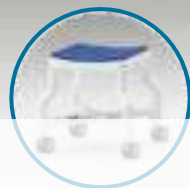

DH 49 DLR PA

DH 49 R, the Shower Stool that travels easily. No tools needed to assemble or disassemble, comes with travel bag. Nesting seat pad PA optional. Weighs 3,8 kg and supports up to 150 kg. Bag dimension: 43 x 43 x 19 cm

DH 49 R



DH 49 R PA



Shower Stools for customers with individual needs

For those who need or want a larger seat area we offer a variety of solutions, starting with the model DH 80 that comes with armrests or the DH 90 that in addition includes a backrest to the model DH 100 that comes with Ø 75 mm twin-wheel swivel caster, all with locks.

Many additional options are available for the customer to create just the stool that fits best.

Like all RCN products these models are made with RCN specific high impact plastic components. They support weights up to 150 kg and the frame is guaranteed for 5 years.

Armrests are standard

PP Soft seat with toilet and hygiene opening made of PUR-foam; simply nests on frame and can be removed, available in 4 colors (see page 78)



PPE Insert for PP seat, optional



Ergonomically designed toilet seat lifts up and can be removed for easy cleaning.



TK Pail with inside scale to measure fluid, this option has to be ordered with the seat, otherwise there will be no rails.



HV Height adjustment in 2,5 cm increments to 7 levels



Highly resistant anti-slip legs

Model DH 90 with backrest
Model DH 80 without



Ø75 mm twin-wheel swivel casters - all locking - are standard for model DH 100 only, optional for all others

Variants of the DH 80, DH 90 and DH 100 models

DH 80

- Armrests
- Ergonomically designed toiletseat, lifts up and can beremoved
- Anti-slip legs
- RCN specific high impact plastic frame

DH 80 HV

- Armrests
- Ergonomically designed toiletseat, lifts up and can beremoved
- Anti-slip legs
- Height adjustment to 7 levels HV
- RCN specific high impact plastic frame

DH 80 PP

- Armrests
- Soft seat with toilet and hygiene opening PP
- Anti-slip legs
- RCN specific high impact plastic frame



All models shown on this page support a load factor of up to 150 kg and are guaranteed not to rust or corrode. The seat height can be made to fit the individual need for no additional cost. For color selection turn to page 78

DH 90

- Armrests
- Backrest
- Ergonomically designed toilet seat, lifts up and can be removed
- Anti-slip legs
- RCN specific high impact plastic frame

DH 90 PP PPE

- Armrests
- Backrest
- Soft seat with toilet and hygiene opening PP
- Insert for soft seat PPE
- Anti-slip legs
- RCN specific high impact plastic frame

DH 100 PP

- Armrests
- Backrest
- Soft seat with toilet and hygiene opening PP
- Ø 75 mm twin-wheel swivel casters - all locking
- RCN specific high impact plastic frame



Toilet Raisers and more ...

DT 100 HV

Toilet Raiser, Rise-Up Aid and Shower Stool, all in one. No tools needed:

- RCN specific high impact plastic frame
- Simply put on top of toilet
- With height adjustment to 7 levels HV
- Splash guard
- Anti-slip legs
- Supports up to 150 kg

DT 100 HM SP

The All-in-One solution. Toilet Raiser, Rise-Up Aid, Shower Stool and Commode.

Like DT 100 HV but additionally with

- Pail and
- Seat Cushion SP

SDH 70

The Stand Stool for people that cannot sit all the way down but need something to rest on.

- Anti-slip legs
- Seat- and backrest pad made of PUR-foam,
- Only available in blue



For color selection see page 78, all products shown on this page are guaranteed NO RUST.

DWH 86

The revolutionary Shower Corner Stool. Put simply in the corner of the shower stall. No drilling holes, no tools. Placed all the way in the corner, between the 90° walls, this stool offers plenty of seat width and legroom.

- Large all plastic seat with open front
- Best use of available space
- Allows one to enter the shower easily and offers plenty of legroom
- Only needs to be placed against two 90° walls
- Suction cups on front legs
- Supports up to 120kg
- Fits easily in even small shower stalls
- Guaranteed NO RUST



XXXL Stools

DH 55 DS

Shower Stool

- RCN specific high impact plastic frame
- Plastic seat with drainholes
- Anti-slip legs
- Supports up to 300 kg

DH 56

Shower Stool

- RCN specific high impact plastic frame
- Plastic seat with drain holes
- Front opening
- Anti-slip legs
- Supports up to 300 kg



Additional XXXL products are shown starting on page 26. Individual sizes upon request. Seat height can be made to fit the individual need for no additional cost.

DT 300 OS DSP

Shower Stool, Commode, Toilet Raiser and Protector of wall mounted toilets, all-in-one

- Additionally reinforced RCN specific high impact plastic frame
- Armrests
- Anti-slip legs
- Plastic seat with toilet and hygiene opening
- Pail with inside scale to measure fluids
- Splash guard
- Supports up to 300 kg

DH 80 OS DSP

Shower Stool

- Additionally reinforced RCN specific high impact plastic frame
- Armrests
- Plastic seat with front opening
- Anti-slip legs
- Seat width 56-60 cm
- Supports up to 250 kg.



Shower- /Commode Chairs

Chairs of the SCC 200 Series offer an affordable entry level to the world of high quality, long lasting, comfortable Multi-Purpose Shower- /Commode Chairs made by RCN. Distinguishing features are the ergonomically designed monobloc seat and backrest made of solid plastic. In typical RCN fashion, these chairs can also be equipped with the all plastic toilet seat or the soft seats made of PUR-foam. Various options to choose from allow you to make any chair fit exactly the customer's special needs. Monobloc seats and backrests are available in three colors: cobalt, graphite and red.

- Very sturdy and easy to clean
- Comfortable design
- Ergonomic
- Skin friendly
- Integrated push handles make transfers safe



More options:



SB Safety-bar, easy to use, provides safety for user and caregiver.



FT Slide-out footrest, anti-tip design, stays on chair, easily glides back and forth



BS Ergonomically designed monobloc seat with toilet and hygiene opening, made of solid plastic



KA Drop-down armrest for easy transfer

SCC 200

Shower- /Commode Chair

- Monobloc backrest with push handles, made of solid plastic
- Ergonomically designed all plastic toilet seat (lifts up and can be removed for easy cleaning)
- Ø75 mm twin-wheel swivel casters - all locking
- Pail with inside scale to measure fluids

SC 200

Shower Chair

- Like above but without pail and rail system

SCC 200 FT

Shower- /Commode Chair

- Monobloc backrest with push handles, made of solid plastic
- Ergonomically designed all plastic toilet seat (lifts up and can be removed for easy cleaning)
- Ø75 mm twin-wheel swivel casters - all locking
- Pail with inside scale to measure fluids
- Slide-out, anti-tip footrest

SC 200 FT

Shower Chair

- Like above but without pail and rail system

SCC 200 and its options



SCC 200 BS FT

The new, ergonomically designed monobloc seat with toilet and hygiene opening goes well with the monobloc backrest and makes this chair a perfect unity in design. This new seat offers through its form and the elasticity of the material a comfortable seating experience and the hygiene opening offers easy access.

- Frame made of RCN specific high impact plastic components
- Monobloc backrest with integrated push handles, made of solid plastic
- Monobloc seat with toilet and hygiene opening, made of solid plastic
- Slide-out, anti-tip footrest
- 4 Ø75 mm twin-wheel swivel casters - all locking
- Can roll over a toilet
- Easy to clean
- Supports up to 150 kg

All models are guaranteed NO RUST, support up to 150kg, seat height can be made to fit over a toilet at no additional cost.



SCC 200 BS

Shower- /Commode Chair like the SCC 200 but with:

- Monobloc seat with toilet and hygiene opening BS

SC 200 BS

Shower- /Commode Chair like the SCC 200 BS, but without:

- Pail and rail system



SCC 200 S

Shower- /Commode Chair like the SCC 200 BS but with:

- Slide-out, anti-tip footrest FT
- Drop down armrest KA
- Safety-bar SB

SC 200 S

Shower Chair like the SCC 200 S, but without:

- Pail and rail system

Multi-Purpose Shower- /Commode Chairs

When you select Multi-Purpose Chairs from RCN you can choose from a multitude of options to “create” the chair that fits the user’s needs best. With their cushioned seats and backrests in lively colors they can even be used as a comfortable room chair. Have a look at all the options presented on these two pages.

These are the main characteristics:

- RCN specific, high impact plastic
- Extremely sturdy, supports up to 150 kg
- Easy to clean
- UV-resistant and compatible with most disinfectants
- Can be rolled over toilets
- 3 year warranty
- 5 year warranty on RCN specific plastic frame

Frame material and contours are agreeable to the touch and skin-friendly

Seat height can be made to fit existing toilet height at no extra cost



For color selection turn to page 78

SCC 250 D SB and more options



SCC 250 D SB

Standard with

- One swing-out armrest ASA (both are optional as 2 ASA)
- Slide-out, anti-tip footrest FT
- Backrest cushion RP and seat cushion SP for use as room chair
- Safety-bar SB

See more options below to further adapt the chair to individual needs



SP Seat cushion on plastic plate, with foam core and cover made of coated fabric



RP Backrest cushion, snaps on to frame with cover made of coated fabric



TK Second pail, handle upon request



Inside scale to measure fluid

These cushions must be taken off prior to showering

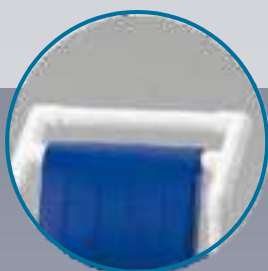

GR Push-bar



HV Height adjustment to adapt seat height and clearance to 5 levels (7 levels on chairs without ASA)



AKA Anti-tip frame for very agitated users



KS Headrest 3D adjustable



NH Slant seat, 3 cm lower in back



SG Safety-belt continuous adjustment, easy to attach on frame



MFT Roll-along footrest after-sale equipment for all chairs



ER Ø 100 mm single-wheel, never rust caster - locking

Multi-Purpose Shower- /Commode Chairs

Chairs of the SCC 250 Series with soft backrest and soft seat made of PUR-foam are especially suitable for the demanding environment in nursing homes and hospitals alike. To select the best suited chair model have a look at all the options presented on these two pages.

Frame material and contours are agreeable to the touch and skin-friendly.

These are the main characteristics:

- RCN specific, high impact plastic
- Extremely sturdy, supports up to 150 kg
- Easy to clean
- UV-resistant and compatible with most disinfectants
- Can be rolled over toilets
- 3 year warranty
- 5 year warranty on RCN plastic frame

Seat height can be made to fit existing toilet height at no extra cost



PR Soft backrest made of PUR-foam, nests on frame and removes easily for cleaning and better access

ASA Swing-out armrest secured by safety clip. Comes standard on right, left upon request and optional on both sides : **2 ASA**

SB Safety-bar, easy to use, lets users and caregivers feel more secure

PP Soft seat with hygiene opening, made of PUR-foam, nests safely on frame and can be taken off for cleaning

Pail with internal scale to measure fluids, made of heat-resistant plastic, handle upon request

Can roll over toilet bowl, seat height can be adapted upon request at no extra cost

Ø75mm twin-wheel swivel casters, - all locking. Excellent mobility in narrow spaces, all-locks provide stable positioning of the chair

FT Slide-out footrest, no forward tipping, glides easily back and forth and always stays with chair

For color selection turn to page 78

SCC 250 PPG SB and more options

RCN offers you more options to further adapt the chair to individual needs.

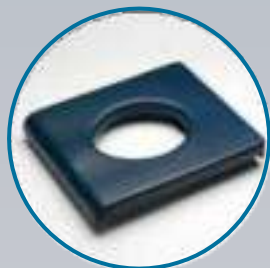

PS Soft seat made of PUR-foam with toilet opening



PSE Insert for soft seat PS



PPE Insert for soft seat PP

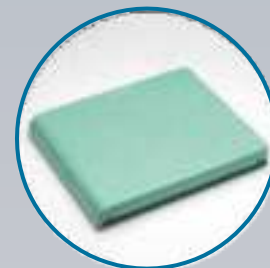

PUS Plain soft seat made of PUR-foam



PZ Soft split seat made of PUR-foam



DRS Anti-slide flips down and can be taken off



TK Second pail, handle upon request



KS Headrest 3D adjustable

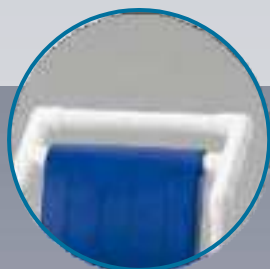

GR Push-bar frame



AP Armrest pad, made of PUR-foam



HV Height adjustment to adapt seat height and clearance to 5 levels (7 levels on chairs without ASA)



AKA Anti-tip frame for very agitated users



UR Splash protector made of PUR-foam, fits all PPseats



NH Slant seat 3 cm lower in back



SG Safety-belt, continuous adjustment, easy to attach on frame



ER Ø 100 mm single-wheel, never rust caster - locking

Multi-Purpose Shower- /Commode Chairs

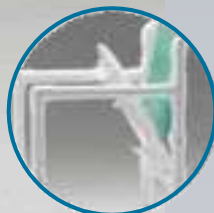
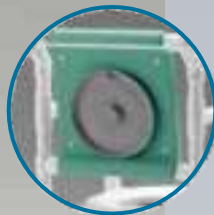

SCC 250

Standard model

- Ergonomically designed toilet seat, lifts up and can be removed
- Ø 75 mm twin-wheel swivel casters - all locking
- Back support made of Textilene® fabric
- Pail with inside scale
- Lid storage on backrest
- Rolls over toilet

SC 100

Same as SCC 250 but

- Without pail and pail rail



SCC 250 HV SB

Same as SCC 250 but with

- Height adjustment to 7 levels (5 levels if ordered with ASA) HV
- Safety-bar SB

SC 100 HV SB

Same as SCC 250 HV SB but

- Without pail and pail rail



SCC 250 FT SB

Same as SCC 250 but with

- Slide-out, anti-tip footrest FT
- Safety-bar SB

SC 100 FT SB

Same as SCC model but

- Without pail and pail rail

All these chair models are guaranteed **NO RUST**, can roll over toilet and support up to 150kg



SC 100 PUS

Shower Chair with

- Solid soft seat made of PUR-foam **PUS**
- Ø 75 mm twin-wheel swivel casters
- all locking
- Back support made of Textilene® fabric



SCC 250 FT PR

Shower- / Commode Chair,
same as SCC 250 but with

- Slide-out, anti-tip footrest **FT**
- Soft backrest made of PUR-foam **PR**,
removable for easy cleaning and
access

SC 100 FT PR

Same as SCC model but

- Without pail and pail rail



SCC 250 D SB

Multi-Purpose Shower- / Commode Chair
Standard with

- Swing-out armrest **ASA**
(2 swing-out armrests optional **2 ASA**)
- Slide-out, anti-tip footrest **FT**
- Backrest cushion with foam core and
cover made of coated fabric **RP**
- Seat cushion with foam core and cover
made of coated fabric **SP**
- Safety-bar **SB**

Seat height and clearance can be
adapted to individual needs at no
additional cost.

Multi-Purpose Shower- /Commode Chairs



SCC 250 PS PR

Shower- / Commode Chair with

- Soft seat with toilet opening, made of PUR-foam PS
- Soft backrest made of PUR-foam PR (PS and PR removable for easy cleaning)
- Ø 75 mm twin-wheel swivel casters - all locking
- Pail with inside scale
- Pail lid holder on all backrests
- Rolls over toilet

SC 100 PS PR

Same as SCC model but

- Without pail and pail rails



SCC 250 PSG SB

Multi-Purpose Shower- / Commode Chair like model SCC 250 PS PR but with

- Slide-out, anti-tip footrest FT
- Swing-out armrest ASA (2 swing-out armrests optional 2 ASA)
- Safety-bar SB

SC 100 PSG SB

Shower Chair

same SCC model but without

- Pail and pail rails



SCC 250 PZG SB

Shower- / Commode chair with total hygiene split soft seat for total access

- Soft backrest made of PUR-foam PR
- Soft split seat made of PUR-foam PZ
- Slide-out, anti-tip footrest FT
- Swing out armrest ASA (2 swing out armrests optional 2 ASA)
- Safety bar SB

SC 100 PZG SB

same as SCC 250 model but

- Without pail and pail rails



SCC 250 PP PPE SB

Shower- / Commode Chair

Same as SCC 250 but with

- Soft seat with toilet and hygiene opening made of PUR-foam PP
- Insert for soft seat PPE
- Safety-bar SB

SC 100 PP PPE SB

Same as above but

- Without pail and pail rails



SCC 250 PP FT

Shower- / Commode Chair

same as SCC 250 but with

- Soft seat with toilet and hygiene opening made of PUR-foam PP
- Slide-out, anti-tip footrest FT

SC 100 PP FT

same as above but

- Without pail and pail rails

All these chair models are guaranteed NO RUST can roll over toilet and support up to 150kg



SCC 250 PPG SB AP ER

Multi-Purpose Shower- / Commode Chair but with

- Soft seat with toilet and hygiene opening made of PUR-foam PP
- Soft backrest, made of PUR-foam PR
- Slide-out, anti-tip footrest FT
- Swing-out armrest ASA (2 swing-out armrests optional 2 ASA)
- Safety-bar SB
- PUR-foam padded armrests AP
- Ø 100 mm single-wheel swivel casters - all locking ER

SC 100 PPG SB AP ER

same as above but

- Without pail and pail rails

Multi-Purpose Shower- / Commode Chairs

SCC 250 PPG SB

Multi-Purpose Shower- / Commode Chair standard with

- Soft seat with toilet and hygiene opening made of PUR-foam PP
- Soft backrest made of PUR-foam PR
- Slide-out, anti-tip footrest FT
- Swing-out armrest ASA (2 swing-out armrests optional 2 ASA)
- Safety-bar SB



SC 100 PPG SB

same as SCC 250 PPG SB model but

- Without pail and pail rails



SCC 250 PPG SB 2 ASA

same as SCC 250 PPG SB model but

- With 2 swing-out armrests ASA



SC 100 PPG SB 2 ASA PPE

same as SCC 250 PPG SB 2 ASA but

- With insert for soft seat PPE
- Without pail and pail rails



SCC 250 PPG SB HV

Multi-Purpose Shower- /Commode Chair
same as SCC 250 PPG SB but with
● Height adjustment to 5-levels HV

SC 100 PPG SB HV

same as SCC 250 PPG SB HV but
● Without pail and pail rails



All these chair models are guaranteed NO RUST can roll over toilet and support up to 150 kg

SCC 250 PPG SB DRS

The Multi-Purpose Shower- / Commode Chair with the additional option DRS, the 100% sure protection against anyone sliding unintentionally off the seat. Eliminates the need for a safety-belt. This optional device can be added to the chair when needed and easily be taken off. It nests on the U bar and clips from the back against the safety-bar SB. Only in combination with Option SB.

- The insert PS can be added to the soft seat PP (2. picture)
Another solution from RCN's creative team!



Multi-Purpose Chairs for special needs

SCC 250 RC

Multi-Purpose Reclining Shower- / Commode Chair model for patients with special needs due to greatly reduced mobility. Back- and leg rest can both be adjusted into 7 individual positions, allowing the person to be seated in the most comfortable position.

- Soft seat with toilet and hygiene opening
- Pail with inside scale to measure fluid
- Drop down armrest
- Ø100 mm single-wheel casters - 2 locking
- Guaranteed NO RUST
- Supports up to 150kg
- Insert for soft seat optional, PPE



KSC 180 FT RP SB

Small Multi-Purpose Shower- / Commode Chairs start at 35 cm seat width. The height adjustment allows to increase the seat height during the child's growing up.

Shown with the options

- Slide-out, anti-tip footrest FT
- Backrest cushion with foam core and cover made of Textilene® fabric RP
- Safety-bar SB



Travel Chairs



Safe travels!



Height adjustment HV
to 5 seat levels

2 Swing-out
armrests 2 ASA

Bag in Textilene® fabric:
63x60x34 cm

SCC 250 R

This Multi-Purpose Shower-/ Commode Chair travels easily in a handy travel bag. No tools needed to quickly assemble or disassemble the chair. Weighs only 10,8 kg yet supports safely 150 kg

- Ø75 mm twin-wheel swivel casters - all locking
- PUR-foam padded backrest
- PUR-foam padded armrests
- Travel bag made of Textilene® fabric
- Pail



SCC 250 KB

Folding Shower-/ Commode Chair,
folds easily to store in tight places

- Ergonomically designed toilet seat, lifts up and can be removed
- Backrest made of Textilene® fabric
- Pail with inside scale
- Ø 75 mm twin-wheel swivel casters - all locking

All these chair models are guaranteed NO RUST can roll over toilet and support up to 150 kg! The seat height can be adapted to individual needs at no extra cost.

XXL-Multi-Purpose Shower- / Commode Chairs

RCN offers Multi-Purpose Shower- / Commode Chairs as XL Series for up to 200kg weight capacity and seat width ranging from 46 to 54 cm and as OS Series for up to 250 kg weight capacity and 56 to 60 cm seat width. Chairs with weight capacities between 250 and 400 kg need to be ordered as custom products to best adapt to individual needs.

- RCN specific, high impact plastic
- Extremely sturdy, supports up to 400 kg
- Easy to clean
- UV-resistant and compatible with most disinfectants
- Can be rolled over toilets (models up to 250 kg only)
- 3 year warranty
- 5 year warranty on RCN specific plastic frame

Frame material and contours are agreeable to the touch and skin-friendly.

Seat height can be adapted to fit existing toilet height at no extra cost

PR Soft backrest made of PUR-foam, nests on frame and removes easily for cleaning and better access. Integrated pail lid holder

ASAOS Swing-out armrest secured by safety-clip. Comes standard on right, left upon request and optional on both sides **2 ASAOS**

Soft seat with toilet and hygiene opening, made of PUR-foam. Nests safely on frame and can be taken off for cleaning
PPOS 44cm width, **PPML** 50cm width
PPXL 56 cm seat width



Pail with inside scale, made of heat-resistant plastic, handle upon request

Ø100 mm single-wheel swivel casters - all locking. Excellent mobility in narrow spaces, all-locks provide stable positioning of the chair

MFTOS Slide-out footrest, rolls along on 4 twin-wheel swivel casters, slides easily back and forth and always stays with chair.



Model SCC 250 OS PPG STE and options

RCN offers you more options to further adapt the chair to individual needs.

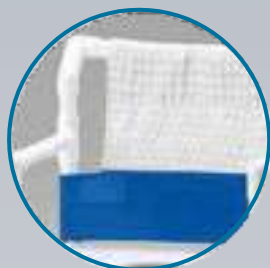

Backrest support made of Textilene® fabric



SPOS Seat cushion on plastic plate, with foam core and cover made of coated fabric

These cushions must be taken off prior to showering



RPOS Backrest cushion, snaps on to frame with cover made of coated fabric



AP Armrest pad, made of PUR-foam

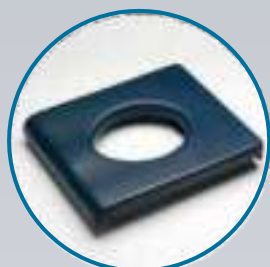

PSOS Soft seat made of PUR-foam with toilet opening



PSE Insert for soft seat PSOS



PPE Insert for soft seat PPOS, PPML, PPXL



PSA Side seat extension



DS Plastic flat seat with toilet opening



DSP Plastic seat with toilet and hygiene opening, can be customized



STE Seat-depth extension to 54 cm, greater depth upon demand



SGOS Safety-belt continuous adjustment, easy to attach on frame



UR Splash protector made of PUR-foam fits all PP seats



ASAOS Swing-out armrest secured by safety clip. Comes standard on right, left upon request and optional on both sides **2ASAOS**



MFTOS Slide-out footrest, rolls along on 4 twin-wheel swivel casters, slides easily back and forth and always stays with chair.



BAOS Roll-along legrest, slant can be adjusted, fits both on left and right side.

The OS Series

SCC 250 OS DS

Basic Model: flat plastic seat with toilet opening (hygiene opening optional) 4 Ø 100 mm single-wheel casters - all locking, contoured backrest with Textilene® fabric support, pail with interior scale, pail lid holder, rolls over toilet, seat width 56 - 60cm.

SCC 250 OS DS ASAOS PR

- Flat plastic seat with toilet opening DS
- Reinforced swing-out armrest ASAOS
- Soft backrest made of PUR-foam, nests on frame and removes easily (see photo) PR, seat width 56-60cm



SCC 250 OS PPG

- Reinforced swing-out armrest ASAOS
- Slide-out, roll-along footrest MFTOS
- Soft backrest PR and soft seat with toilet and hygiene opening, made of PUR-foam PPXL, seat width 56-60cm

SCC 250 OS PPG STE

- Reinforced swing-out armrest ASAOS
- Slide-out, roll-along footrest MFTOS
- Soft backrest PR and soft seat with toilet and hygiene opening, made of PUR-foam PPXL
- Seat depth extension to 54cm STE, seat width 56-60cm
- Splash protector (optional) UR



Chairs for the bariatric environment

SCC 250 OS D

- Flat plastic seat with toilet opening DS
- Reinforced, swing-out armrest ASAOS
- Slide-out, roll-along footrest MFTOS
- Backrest cushion with cover made of coated fabric RPOS
- Seat cushion with cover made of coated fabric SPOS

These cushions must be removed prior to showering.
Seat width 56-60 cm



For color selection see page 81

SCC 250 OS DS ASAOS MFTOS

- Flat plastic seat with toilet opening DS
- Reinforced, swing-out armrest ASAOS
- Slide-out, roll-along footrest MFTOS,
seat width 56-60 cm



All OS Models
support up to
250 kg

For maximum toilet heights see data on page 81

We recommend to equip all chairs for the bariatric environment with the footrest option MFTOS

The Top-Model of the OS Series

SCC 250 OS PPG 2 ASAOS STE

Comes standard with

- Reinforced, swing-out armrests, left and right, 2 ASAOS
- Slide-out, roll-along footrest MFTOS
- Soft backrest PR and soft seat with toilet and hygiene opening, made of PUR-foam PPXL
- Seat depth extension to 54cm STE
- Seat width 56-60 cm
- Supports up to 250 kg



Select Models of the XL Series

SCC 250 XL DS

Basic Model: flat plastic seat with toilet opening (hygiene opening optional) 4 Ø 100 mm single-wheel casters - all locking, contoured backrest with Textilene® fabric support, pail with interior scale, pail lid holder, rolls over toilet.

Seat width 50-54 cm. Supports up to 200 kg.



SCC 250 XL PPG

- Swing-out armrest on right **ASAXL**
- Slide-out, roll-along footrest **MFTOS**
- Soft backrest **PR** and soft seat with toilet and hygiene opening made of PUR-foam **PPML**

Seat width 50-54 cm. Supports up to 200 kg.



SCC 250 XL PPG PPE

Same as SCC 250 XL PPG but with

- Insert **PPE** to cover toilet and hygiene opening

Seat width 50-54 cm. Supports up to 200 kg.



SCC 250 XL PPG STE

Same as SCC 250 XL PPG but with

- Seat depth extension to 54 cm **STE**

Seat width 50-54 cm. Supports up to 200 kg.



XXXL Multi-Purpose Shower-/Commode Chairs



Supports up to

300 kg

SCC 250 XXXL 300 kg

Chairs for higher weight requests are custom made to fit all requirements of the customer. This describes but one of many examples:

- Double framed back made of RCN specific plastic, reinforced with inside aluminum tubing
- Soft backrest made of PUR-foam PR
- Flat, all plastic seat with toilet and hygiene opening DSP
- 6 Ø100 mm single-wheel swivel casters - 4 locking
- Anti-tip, slide-out, roll-along footrest
- Seat width: 70 cm
- Seat depth extension to 54 cm STE
- Pail with interior scale to measure fluids
- Guaranteed NO RUST
- Waterproof seat cushion optional



Supports up to

400 kg

SCC 250 XXXL 400 kg

- Swing-out armrests, reinforced, on both sides 2 ASAOS
- Double framed back made of RCN specific plastic, reinforced with inside aluminum tubing
- 2 Soft backrest made of PUR-foam PR
- Flat, all plastic seat with toilet and hygiene opening DSP
- 6 Ø100 mm single-wheel swivel casters - 4 locking
- Anti-tip, slide-out, roll-along footrest
- Seat width: 80 cm
- Seat depth extension to 54 cm STE
- Pail with interior scale to measure fluids
- Guaranteed not to rust
- Waterproof seat cushion optional



Customer specific solutions for bariatrics

RCN's proprietary modular system is ideally suited to respond to very specific product requirements. Contact us for any special solutions.

We specialize in offering fast turnaround and affordability.



Wheelchairs



DR 100 PPG

Shower-Wheelchair with 24" wheels, soft seat width 44 cm, supports up to 150 kg.

- Swing-out armrest on both sides 2 ASA
- Slide-out footrest FT
- Soft backrest PR and soft seat with toilet and hygiene opening PP made of PUR-foam
- Can roll over toilet
- Guaranteed not to rust

DR 250 PPG (not pictured)

Same as DR 100 PPG but with

- Pail and pail rail



Locks, non-rusting



DR 400

Robust Transfer Chair, seat width 44 cm, supports up to 150kg

- Seat- and Backrest Cushion with foam core and water repellent coated fabric
- Armrest pads made of PUR-foam AP
- Slide-out footrest FT
- 2 wheel locks
- Push-bar
- Swing-out armrest on both sides 2 ASA
- Clothes protectors

For color selection see page 81

XXL Wheelchairs



DR 250 XL PPG

Shower- /Commode-Wheelchair with 24" wheels, comes standard with

- Swing-out armrests on both sides 2 ASAXL
- Slide-out, roll-along footrest MFTOS
- Soft backrest PR and soft seat with toilet and hygiene opening PPML made of PUR-foam

Seat insert to cover toilet and hygiene opening PPE (optional)

Seat width 46-54 cm. Supports up to 175 kg. XXL Wheelchairs cannot roll over a toilet!



DR 250 OS PPG (not pictured)

Shower- /Commode-Wheelchair with 24" wheels, comes standard with

- Swing-out armrests on both sides 2 ASAXL
- Slide-out, roll-along footrest MFTOS
- Soft backrest PR and soft seat with toilet and hygiene opening PPXL made of PUR-foam

Seat insert to cover toilet and hygiene opening PPE (optional)

Seat width 56-60 cm. Supports up to 200 kg. XXL Wheelchairs cannot roll over a toilet!



SCC 250 Comfort E - a unique Tilt-Chair

The SCC 250 Comfort E - with lots of capabilities

This Multi-Purpose Shower- / Commode Tilt-Chair is ideally suited to assist in the care of people with minimal upper body strength or that are hyperactive. When sitting upright or lying down is difficult, the tilt position of this chair is both relaxing and comfortable.

We paid special attention to making the continuous reclining movement very smooth to avoid any sudden fear reaction. Thus, the person can be optimally positioned.

The robust construction, using high quality, large aluminum tubing - powder coated - gives the SCC 250 Comfort E a very high safety rating. Handling the control box is easy and effortless and allows the caregiver to always keep eye contact and to reassure the patient in the chair.

Footrests, armrests, head support, extra soft PUR-foam seat and backrest assure functionality and comfort of this Tilt-Chair.

Guaranteed NO RUST, supports up to 150 kg!



Pictured with optional seat insert to cover toilet and hygiene opening PSE

Features and benefits of this unique Tilt-Chair

Take a closer look:

3D adjustable headrest



Soft backrest made of PUR-foam, removes easily for cleaning



PUR-foam padded armrest lifts up

Soft seat with toilet and hygiene opening, nests on frame and removes easily for cleaning

Battery driven actuator

Control box

Anti-tip frame with optimal tilt point

Ø 100 mm twin-wheel swivel casters - all locking

Pail with interior scale to measure fluid TK

Individually adjustable footrests

Insert to cover seat opening PSE (optional)

Tilt angle infinitely adjustable from -5° to +40°



You came to the right place!

RCN Gurneys can be used for showering and transferring patients in and out of the shower room. Models of the UDL Series offer customary RCN quality at a very affordable cost - a true alternative for tighter budgets. Their sturdy frames, made with RCN specific plastic components, are built to support high load factors while being lightweight and offering exceptional longevity. The soft tub-liner offers comfort, is easy to disinfect and to clean. The drain hole can be closed, allowing the tub-liner to be filled with water and giving the user a feel of bathing.

A large evacuation tube (90 cm long) ensures controlled water evacuation. Both side rails drop down for easy transfer. For even easier transfer consider adding a roll-board, shown on page 41. Single-wheel swivel casters - all locking and guaranteed NO RUST, ensure high mobility.

- Affordable
- Easy and smooth in-house transfers
- Comfortable due to padded tub-liner
- Guaranteed NO RUST
- 3 year warranty
- 5 year warranty on RCN specific plastic frame

UDL 1500

- Drop-down side rails
- Padded liner
- Large drain hose, 90 cm long
- Single-wheel swivel NO RUST casters - all locking
- RCN specific plastic frame
- Supports up to 150kg
- For persons with 182 cm in height
- Shoulder width 61cm



Shower- and Transfer Gurneys

UDL 1500 DK

- Drop-down side rails
- Padded liner
- Large drain hose, 90 cm long
- Single-wheel swivel NO RUST casters - all locking
- RCN specific plastic frame
- Supports up to 150 kg
- For persons with 182 cm in height
- Shoulder width 61 cm
- Wedge pillow DK



UDL 1500 VR

- Drop-down side rails
- Padded liner
- Large drain hose, 90 cm long
- Single-wheel swivel NO RUST casters - all locking
- RCN specific plastic frame
- Supports up to 150 kg
- For persons with 182 cm in height
- Shoulder width 61 cm
- 6 position backrest adjustment VR



Small, pediatric Shower- and Transfer Gurneys

UDL 500

- Drop-down side rails
- Padded liner
- Large drain hose, 90 cm long
- Single-wheel swivel NO RUST casters - all locking
- RCN specific plastic frame
- Supports up to 150kg
- For persons with 146 cm height
- Shoulder width 48cm



UDL 750

- Drop-down side rails
- Padded liner
- Large drain hose, 90 cm long
- Single-wheel swivel NO RUST casters - all locking
- RCN specific plastic frame
- Supports up to 150 kg
- For persons with 162 cm height
- Shoulder width 53 cm



Individual features of the UDL Series



Large drain hose 90 cm



Drain hole with plug



All plastic plate sturdy and durable



Wedge pillow DK



Side rails drop down on all models, option VR allows backrest to be adjusted to 6 positions (picture on right)



Transfer and repositioning aids are great assists in getting people from bed on to a gurney and back

Patient Transfer Board PTB (no carrying)

- High impact plastic
- Translucent
- For weights up to 120 kg
- 180 x 60 cm



Transfer Roll-Board TRB

Ideal for easy transfers, glides smoothly, helps avoid back pain and physical stress in moving heavier and less mobile patients from bed on to a gurney and back

- Board made of Polyethylene
- Cover made of Nylon
- Supports up to 200 kg
- TRB 180: 180x50cm
- TRB 195: 195x50cm

The stainless Shower Gurney - height adjustable

The Series UDW Shower Gurneys from RCN are ideal for transporting and showering patients. Via foot pedals on both sides, the deck height can be adjusted from 49 to 89cm. The soft tub-liner offers comfort, is easy to disinfect and to clean.

Side- and foot end rails drop down, allowing easy transfer for persons with reduced mobility. The head end rail can be put in a lateral position to extend the length of the deck by 15 cm. A manually activated pneumatic-spring assists to move the deck into a Anti- / Trendelenburg positioning.

Large drain hose ensures controlled water evacuation. Ø 100 mm twin-wheel swivel casters - 4 locking - offer easy transport and great mobility. Models with the option VRW include a continuously adjustable backrest by a manual spindle drive.

- Continuously adjustable backrest option VRW
- Drop-down side- and foot-end rails
- Lateral deck extension
- Height adjustable from 49 to 89 cm
- Anti- / Trendelenburg positioning
- Guaranteed NO RUST

Unbeatable in quality, performance and total cost of ownership !

UDW 2500

Flat plastic deck, backrest not adjustable (not pictured)

- Drop-down side- and foot-end rails
- Lateral deck extension
- Soft tub-liner with drain hose, 90 cm
- Height adjustable from 49 to 89 cm
- Anti- / Trendelenburg positioning
- Supports up to 200 kg
- For persons with 185 / 200 cm in height
- Shoulder width 62 cm

UDW 2500 VRW

Flat plastic deck, adjustable backrest (see picture)

- Drop-down side- and foot-end rails
- Lateral deck extension
- Soft tub-liner with drain hose, 90 cm
- Height adjustable from 49 to 89 cm
- Anti- / Trendelenburg positioning
- Continuously adjustable backrest VRW
- Supports up to 200 kg
- For persons with 185 / 200 cm in height
- Shoulder width 62 cm



Selection of the UDW Series

Drop-down side- and foot-end rails

Padded soft tub-liner

Head-end rail drops into lateral position, extending the deck by 15 cm

Crank handle to adjust backrest position, option VRW

Pneumatic-spring to assist move to Anti- / Trendelenburg positioning

Drain hole and 90cm drain hose

Hydraulic cylinder for height adjustment of deck by foot pedal, ensures steady lowering speed independent of weight

Stainless steel frame, powder coated for easy cleaning

Foot pedal activation on both sides

Ø100 mm twin-wheel swivel casters - 4 locking

NO RUST - Guaranteed



Adjustable backrest, drop-down foot-end and side rails, head-end rail drops into lateral position



Height adjustment from 49 to 89 cm

Anti- / Trendelenburg Positioning

Shower Gurneys - big and small - Series UDW

UDW 4500 XXL

Similar to the UDW 2500 but supporting a higher weight and offering push handles to ensure easy mobility. The XXL version supports up to 400 kg. Equipped with a special hydraulic cylinder to make height adjustment an

easy task even when fully loaded. Lowering speed remains steady, independent of load factor. Continuously adjustable backrest optional VRW

Picture: UDW 4500 XXL VRW

- Drop-down side- and foot-end rails
- Lateral deck extension
- Soft tub-liner with drain hose, 90 cm
- Height adjustable from 52 to 92 cm
- Anti- / Trendelenburg positioning
- Ø 100 mm twin-wheel swivel casters
 - 4 locking
- Continuously adjustable backrest **VRW**
- Supports up to 400 kg
- For persons with 185 / 200 cm in height
- Shoulder width 95 cm
- Other sizes upon request



Supports up to
400 kg

UDW 650

The small version of the UDW 2500. Offers the same features and benefits and can also be equipped with the Option VRW.

- Drop-down side- and foot-end rails
- Lateral deck extension
- Soft tub-liner with drain hose, 90 cm
- Height adjustable from 49 to 89 cm
- Anti- / Trendelenburg positioning
- Ø 100 mm twin-wheel swivel casters
 - 4 locking
- Continuously adjustable backrest **VRW**
- Supports up to 150 kg
- For persons with 162 / 177 cm in height
- Shoulder width 54 cm
- Other sizes upon request



Picture: UDW 650 VRW

Customized solutions - not a problem!

Custom built

We are your partner when you need a solution for a special need. We listen intently, discuss with you what you need and work out potential solutions. Then our specialized team of engineers works out the details and prepares drawings for you to approve. This way you can be sure to receive exactly the product you need.

Due to the RCN modular construction we can not only act quickly but also offer affordable product solutions.

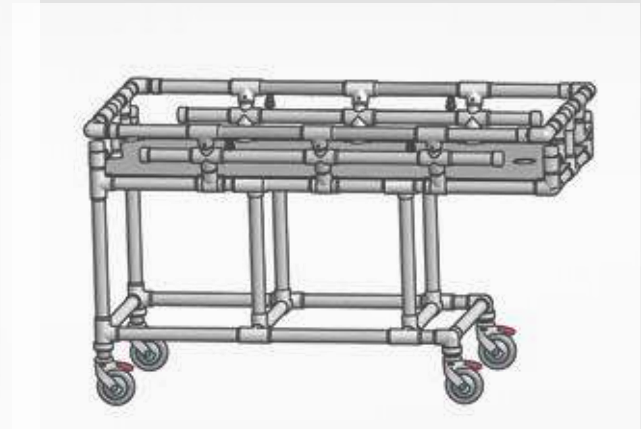
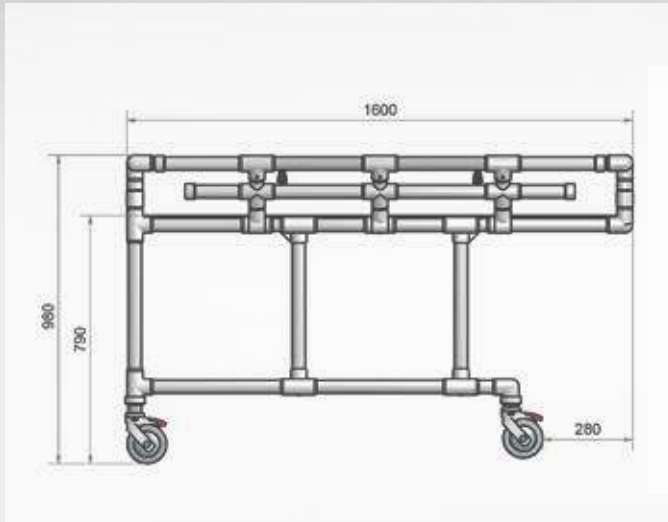

Custom built Shower Gurney

Here is a picture of the finished product, manufactured based on the drawings above.

The requirements came from a narrow bathroom space and a narrow bathroom door.

Our solution: a shorter base frame and a deck to fit the height of the patient. Side rails are in a vertical position to fit through the narrow door and special plastic clips hold the soft tub-liner in place.



The RCN Walker - for safer mobility

Der GW 120

The aid that keeps people with walking impairments mobile and helps avoid restraints.

Comes standard with:

- Seat made of PUR-foam
- Safety-bar with safety-belt
- Anti-tip frame extension
- 6 Ø 75 mm twin-wheel swivel casters
 - 4 locking - provide great mobility
- Height adjustment to 7 levels
- Tote bag
- Supports up to 150 kg



A Walker like none other

The RCN Walker offers safety in movement like no other walking aid. It was developed with the clear aim to keep people with increasing walking difficulties moving without fear thus keeping them mobile longer. Patients feel safe to walk due to the integrated seat that lets them sit down and rest whenever they need. It invites them to walk, stay mobile and is thus a very valuable aid for therapeutic exercise.

The anti-tip, all around frame and the integrated seat together with the safety-belt greatly reduces fear of falling and protects against falling. Staying mobile has, of course, very positive effects on any person's overall condition. Keep Patients out of the wheelchair and avoid restraints - with the Walker from RCN.

A few easy steps prepare the walker for the user.



Lock all four casters, open the safety-bar and the safety-bar

Let the user enter the Walker and adjust the seat height.



After adjusting the seat height let the user sit down comfortably close the safety-bar, then close the safety-belt and pull it firm.

Let the user make a few steps to evaluate if the person uses the Walker with controlled ease. Never let the Walker be used without first evaluating its safe handling by the user.

Features and options

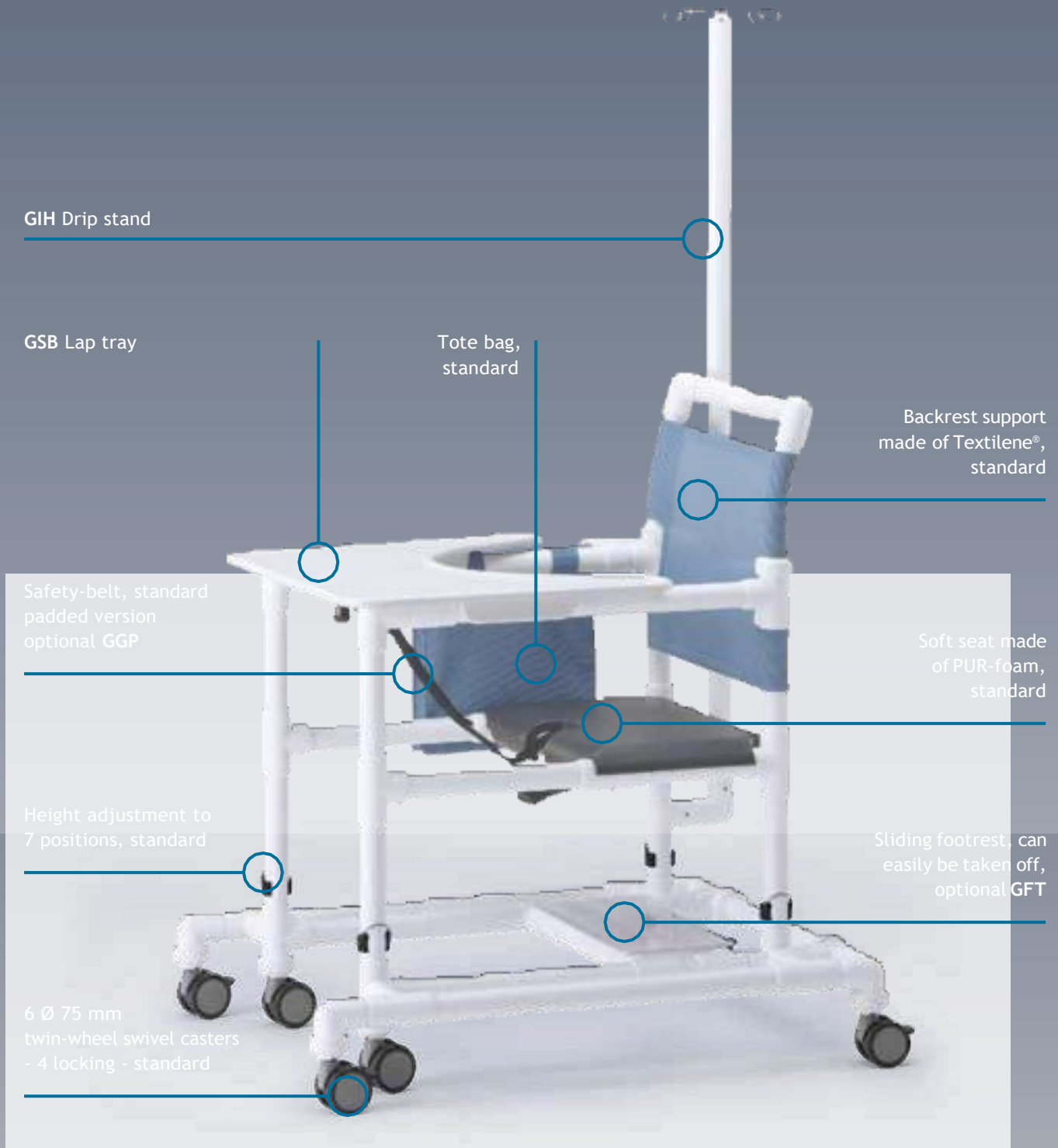

For color selection see pages 82 and 83



Anti-tip safety-frame, standard



Safety-bar standard



Height adjustment to 7 positions standard



GGP Safety-belt



GKGW Gel-Cushion



GL Slider slows or stops Walker

The original Walker: GW 120



The GW 120:

- Safe mobility and more quality of life
- Helps to avoid restraints
- Soft seat made of PUR-foam
- Safety-bar and safety-belt
- Anti-tip all-around frame
- 6 Ø 75 mm twin-wheel swivel casters
- 4 locking
- Height adjustment to 7 positions
- Tote bag
- Supports up to 150 kg



Other Walker models

GW 120 AFS

The GW 120 with wall protectors made of PUR-foam AFS



Wall protector
AFS



GW 120 Mini Pediatric Walker

- For a body size up to 155 cm
- Seat cushion, made of water repellent coated fabric, foam core



GW 120 Maxi

The Walker for tall and oversized users

- Supports up to 200 kg
- Seat cushion, made of water repellent coated fabric, foam core



Combo-Walker CW 300

Walker and gait trainer for patients that lack sufficient strength in their forearms to use the original RCN Walker, arm height adjustable to allow comfortable positioning of the elbows on the soft pad.

If needed, the patient can be secured with a flexible seat attached to the frame by adjustable belts. The patient can thus walk and sit to rest without leaving the Walker. Upper frame is height adjustable in 25 mm increments from 1020 mm up to 1170 mm.

Options upon request.



Quality makes all the difference

Multi-Purpose Carts, Nursing Carts, Hygiene and Isolation Carts, Chart Carts, Linen Carts, Linen Hampers, they are all made of the RCN specific plastic components and, in combination with top of the line RESOPAL® - HPL waterproof wooden plates, offer the best in strength and longevity. Smooth gliding, sturdy drawers and rugged covers are more outstanding features that make working with this equipment easy and productive.

Functionality and ease of handling are requirements that we strive to achieve with every RCN product design.

This, together with our unrelenting drive for quality make RCN the equipment brand of choice.

- Positively NO RUST
- Adaptable to your needs
- Custom-made at affordable cost
- 3 year warranty
- 5 year warranty on RCN specific plastic frame



Ask us for customer specific solutions,
we like being helpful.

No other Hamper does it better

Linen Hampers from RCN - the attractive, robust and quiet alternative to conventional systems.

- Low noise, odor containing lids are standard
- Very mobile due to Ø75 mm twin-wheel swivel casters, - 2 locking
- Sturdy bag hanging solution, holding bags positively in place - NO SLIPPING
- Lids available in 5 colors
- Lids protected against overextending
- Sturdy and stable RCN specific plastic frame
- Cleans easily, lids lift off without tools
- Available in single, double, triple, quadruple and quintuple versions

For color selection see page 83



SLH 022 FP

Three easy steps to hang the bag securely!



1. Open lid and lift the 2 plastic coated hangers



Lid protected against breaking through over-extending



Lid opening with foot pedal FP (optional)



2. Place bag inside - slide over the hangers and push down onto the frame



WSW
Self-emptying bag with closure pin



WSD
Leak-proof bag machine washable



3. The bag is now securely in place and cannot slide

Select lid colors at no extra cost



white



yellow



red



green



blue

Collect, sort and transport soiled linen - efficiently



SLH 021 FP
 ● Single hamper
 ● With foot pedal FP



SLH 023 FP
 ● Triple hamper
 ● With foot pedal FP



SLH 022
 ● Double hamper



SLH 024 FP
 ● Quadruple hamper
 ● With foot pedal FP

Other configurations of multiple hampers - connected or detachable



SLH 023 B FP
 ● Triple (2+1) hamper
 ● With foot pedal FP



SLH 024 B FP ESP 2 HSP ATS
 ● Quadruple hamper
 ● With foot pedal FP
 ● With liquid dispenser ESP and drip-tray ATS
 ● Two glove dispensers 2 HSP

Liquid and glove dispensers optional either on:



sliding rail or



firmly attached

Please note that all hampers are pictured with bag option WSW

RCN Linen Hampers and Waste Collectors

SLX 031 FPX

- Single Jumbo Hamper
- With food pedal FPX



SLX 032 FPX

- Double Jumbo Hamper
- With food pedal FPX



RCN Jumbo Hampers

Jumbo Hampers offer more room for more linen, up to 180 ltr. per bag. This saves steps and time.

Options to equip these Jumbo Hampers with:

- Hands-free lid opening through foot pedal FPX
- Self-emptying polyester bags with closure pin WSWX
- Extra durable support bag made of Textilene® with zipper opening for easy removal of plastic liner WSX

Lids in



white



black

Please note that the above models are pictured with options WSWX and WSX

RCN Waste Collectors - an inexpensive alternative

They come with the RCN specific bag holding system, as single, double or triple units and are often used for separating recyclable materials. The basic model comes as a stand-alone unit. For mobile units you can choose from a list of options.

- Lid opening with foot pedal FP
- Ø 75 mm twin-wheel swivel casters - 2 locking R
- Extra durable support bag made of Textilene® fabric (see Jumbo Hamper above) WSH
- Models are shown with optional plastic bags WSK



MS 120
Stand-alone
WasteCollector



MS 120 R
Single unit with
casters



MS 240 FP R
Double unit with
lid opening with
foot pedal



MS 320 G
Waste Collector for
outside with push
handle and bigger
wheels

Responding to all your needs

HSP Glove dispenser made of aluminum, powder coated, mounted on a slide rail



Upright push bar standard with option **SPL**



Vertical or lateral push-bars standard



ESP Liquid dispenser on slide rail for bottles containing 0,5 ltr optional for 1 ltr. bottles



SPL Slide-out writing platform

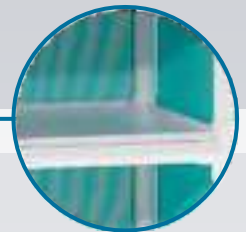

Sturdy shelves in three sizes, injection molded, removable without tools, standard



Ø 75 mm twin-wheel swivel casters for best mobility - 2 locking

Ø 100 mm single-wheel swivel caster for easy transport, - 2 locking

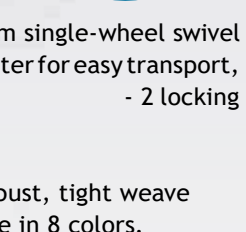

KP Easy to handle docking system to attach hamper to cart



FA Roll-up front cover, robust, tight weave Textilene® fabric, available in 8 colors. For color selection see page 83



Nursing Carts

MC 231 S WSW

- 3 shelves, size 1
- Single hamper
- Lid opening with foot pedal FP
- Liquid dispenser on slide rail ESP
- Glove dispenser on slide rail HSP
- Roll-up front cover FA
- Self-emptying bag WSW



MC 332 S SPL WSW

- 3 shelves, size 2
- Double hamper SLH 022, detachable
- Lid opening with foot pedal FP
- Liquid dispenser on slide rail ESP
- Glove dispenser on slide rail HSP
- Roll-up front cover FA
- Docking system KP
- Slide-out writing platform SPL
- Self-emptying bag WSW



MC 633 S WSW

- 3 shelves, size 2
- Triple hamper SLH 023 B
- Lid opening with foot pedal FP
- Liquid dispenser on slide rail ESP
- Glove dispenser on slide rail HSP
- Docking system KP



MC 642 FP ESP HSP WSW

- 4 shelves, size 2
- Double hamper
- Lid opening with foot pedal FP
- Liquid dispenser on slide rail ESP
- Glove dispenser on slide rail HSP



Making your work easier

MPC Series

These Multi-Purpose Station Carts offer the best in quality and ease of handling. Frames made of RCN specific plastic components and cabinets made of high quality laminate board that comes in many colors guarantee years of trouble-free use.

The cabinets are made with scratch resistant RESOPAL® HPL plates (18mm poplar wood core, laminated under high pressure with 0,8mm Duroplastic film) which are also heat resistant, UV stable, hygienic and easy to clean.

For color selection see page 84



Nursing Carts

MPC 370 ESP HSP K3

- MPC 370 Series Cabinet
- Drawer with lock
- Liquid dispenser ESP
- Glove dispenser HSP
- 3 stainless steel baskets K3



Dividers optional

MPC 370 ABH

- MPC 370 Series Cabinet
- Drawer with lock
- 2 swing doors
- Height adjustable shelf
- Waste container, 40 ltr capacity ABH



MPC 372 S

The MPC 370 Series Select Model, combines cart and double hamper into one easy moving work station

Cart comes with

- Drawer with lock
- 2 swing doors
- Height adjustable shelf
- Liquid dispenser on slide rail ESP
- Glove dispenser on slide rail HSP
- Docking system KP double hamper
- Lid opening with foot pedals FP

Hampers are shown with optional bags WSW

Cart variations

MPC 360 ABW

- MPC 360 Series Cabinet
- Lamellae door with lock
- Waste container, 20 ltr ABW (apply knee pressure to open lid)
- Push-bar
- 2 height adjustable shelves inside



MPC 370 ESP HSP PM

- MPC 360 Series Cabinet
- Drawer with lock
- 2 swing doors
- Height adjustable shelf inside
- Liquid dispenser on slide rail ESP
- Glove dispenser HSP
- Bag for transfer aids PM



MPC 470

- MPC 470 Series Cabinet
- Drawer with lock
- 2 swing doors, lock optional
- Height adjustable shelf inside
- Push-bar



MPC 472 S

The MPC 470 Series Select Model combines cart and double hamper SLH 022 into one moving work station

- Drawer with lock
- 2 swing doors
- Height adjustable shelf inside
- Liquid dispenser on slide rail ESP
- Glove dispenser HSP
- Docking system KP to attach double hamper SLH 022 to Cart
- Lid opening with foot pedal FP



Hampers shown with optional bags WSW

Multi-Purpose Carts

MPC 253 AS 50

- 3 shelves, size 2
- Slide out drawer AS 50

A variety of carts for your daily rounds, made of RCN specific plastic components, offering sturdiness and longevity while being lightweight. Equipped with Ø 100 mm single-wheel swivel casters they roll easily and quietly. A multitude of options give you the choice to adapt the cart to your specific needs. Injection molded shelves support up to 35 kg.

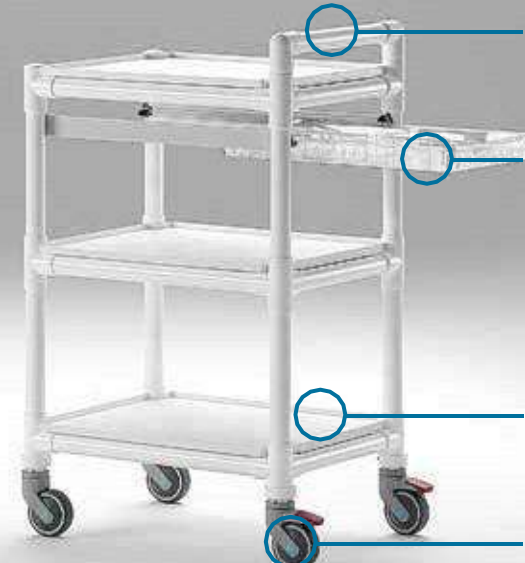

Push-bar

Slide-out drawer AS
in various heights

- AS 50 50 mm height
- AS 110 110 mm height
- AS 200 200 mm height

Removable shelves
- no tools needed -
in 3 sizes

Ø 100 mm single-wheel swivel casters for a smooth and quiet ride

Options:

- WS** Wash bowl
- ESP** Liquid dispenser on slide rail
- HSP** Glove dispenser on slide rail

MPC 153

Multi-Purpose Cart

- 3 shelves, size 1

MPC 253

Multi-Purpose Cart

- 3 shelves, size 2

MPC 353 ESP HSP

Multi-Purpose Cart

- 3 shelves, size 3
- Liquid dispenser on slide rail ESP
- Glove dispenser on slide rail HSP



Plenty of room for clean linen

Linen Carts from RCN come in many different sizes; the carts of the MLC Series offer space and mobility, even fully loaded, due to high quality single-wheel swivel casters and their sturdy RCN specific plastic frame. Shelves can be easily removed without tools and are easy to clean. Covers made of tight weave Textilene® fabric come in 8 colors.

MLC 203

- Linen carts
- With 3 shelves,
 - Cover opens on all sides
 - Push-bar

Covers in 8 colors, open on all sides

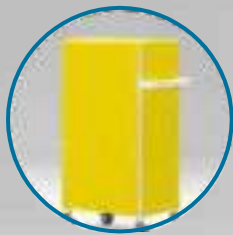

Ergonomic push-bar

Injection molded shelves are removable without tools come in three sizes, support up to 35 kg

Ø 100 mm single-wheel swivel casters
- 2 locking - provide easy and quiet mobility



For color selection see page 83

LC 503

Linen Truck for heavier linen

- Reinforced construction
- 3 shelves sizes 5
- Support up to 40 kg
- Push-bars on both sides



WB 312

Clothing cart for personalized laundry to facilitate transport and distribution

- Push-bars on both sides
- With clothes rail and 12 bins also available with 6 (WB 306) or 18 (WB 318) bins



Linen Carts, clothing carts and garment racks

MLC 204

Linen Cart with

- 4 shelves, size 2
- Cover, opens on all sides
- Push-bar



MLC 303

Linen Cart with

- 3 shelves, size 3
- Cover, opens on all sides
- Push-bar



MLC 304

Linen Cart with

- 4 shelves, size 3
- Cover, opens on all sides
- Push-bar



GR 50

Garment Rack to distribute hanging clothes and other personal items

- Bottom shelf, size 4



WT 424 KS

Laundry Distribution Cart, makes sorting and distributing of folded laundry easy

- Push-bar on both sides
- Retractable clothes rail KS (optional)
- Shown with 24 bins, available also as WT 418 (18 bins) and WT 430 (30 bins)



Chart Carts - from RCN

These versatile carts come in many sizes, configurations and colors. Each cart offers fully accessible space for suspended charts and folders.

Size and configuration can be adjusted to your individual needs.

MDC 85 FB

Mobile Chart Cart with

- Sliding top plate, lockable
- Bottom shelf



Sliding top plate with lock

Bin made of scratch resistant laminate RESOPAL® HPL (see page 85)

Sturdy RCN specific plastic frame

Removable shelf FB

4 twin-wheel swivel casters, Ø75mm - all locking



MDC 95

Chart Cart

- 2 pull-outs for suspended charts
- 1 drawer
- Central lock



MDC 100

Chart Cart

- Sliding top plate, lockable
- 3 drawers



Custom solutions - all you have to do is ask us

RCN's modular system offers many ways to respond to your individual needs and custom build products for you. Just tell us what you need, what size, configuration, responding to what special requirement, send us a rough sketch or precise plan and we will find a solution.

Our technical staff will provide you with a drawing in 3D, make changes if needed and submit a final quote to you. Once approved by you, we shall custom build the special product for you.

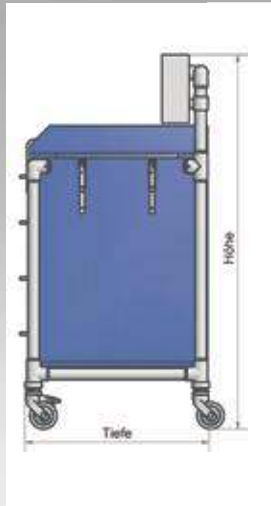
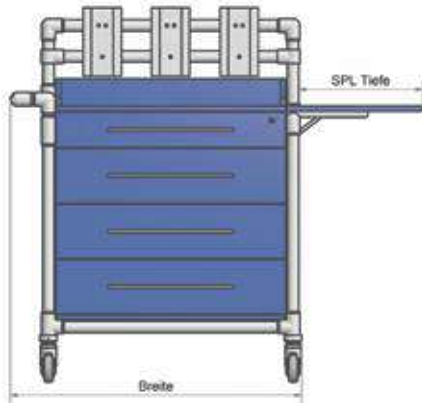

Example of a 3D drawing based on information provided by customer

Custom built product before being shipped

Meeting other customer requests



Isolation Carts to help fight MRSA

The fight against MRSA infection is a growing concern in health facilities. Working with health specialists, RCN has developed a number of carts that fulfill practical needs in this ongoing fight. These carts are lightweight, mobile and can be placed quickly where needed - in front of an isolation room or inside the air lock area.

They offer ample space in transparent drawers for all necessities like gloves, gowns, face masks etc. Their top plate offers plenty working and writing space.

Made with RCN specific plastic components and rolling on 4 twin-wheel swivel casters Ø 75 mm - 2 locking - ideally suitable for this demanding environment.



To fit every need, you can choose from a multitude of options;



HSP
Glove dispenser on slide rail



D-HSP
Triple glove dispenser on slide rail



ABH
Waste container with divided swing lid



ESP
Liquid dispenser on slide rail, standard for half liter bottles, liter bottles upon request



ABF
All plastic top plate
for 4 drawer unit **ABF-K**
for 3 drawer unit **ABF-H**



ATS
Drip tray fits under ESP

Hygiene- and Isolation Carts

KTW 100

- Two plus two transparent drawers
- 4 Ø75mm twin-wheel swivel casters
 - 2 locking
- Sturdy frame made of RCN specific plastic components



KTW 100 HS

like KTW 100 but with

- Liquid dispenser on slide rail **ESP**
- Glove dispenser on slide rail **HSP**
- All plastic top-plate **ABF-K**



KTW 100 HS ATS ABH

Like KTW 100 HS but with

- Drip tray **ATS**
- Waste container with divided swing lid **ABH**



KTW 100 HS ATS SPA

Like KTW 100 HS but with

- Drip tray **ATS**
- Holder for sharps disposable container **SPA**



SPA

Hygiene- and Isolation Carts

HGW 50

Three drawer cart with

- 4 Ø75mm twin-wheel swivel casters
- 2 locking
- Sturdy frame made of RCN specific plastic components



HGW 100 ATS

like HGW 50 but with

- Liquid dispenser on slide rail **ESP**
- Glove dispenser on slide rail **HSP**
- All plastic top plate **ABF-H**
- Drip tray **ATS**



HGW 100 S

Like HGW 50 but with

- Liquid dispenser on slide rail **ESP**
- Triple glove dispenser on slide rail **D-HSP**
- All plastic top plate **ABF-H**
- Waste container, 40 ltr with divided swing lid **ABH**



More Carts to choose from ...

HGW 100 SPS

Like HGW 50 but with

- 10 small flip-out containers
- All plastic top plate ABF-H



LTW 200

Nursing Cart with

- 6 transparent drawers



Waste Containers should allow hands-free operation and should hold odors in check through firmly closing lids. They also should be easy to clean, mobile and off the floor.

The MSR Series of RCN Waste Containers and waste stations offer all this in exemplary fashion. They come in different sizes, colors, are off the floor on mobile frames with Ø 75 mm twin-wheel swivel casters. The containers come in volumes of 30, 45, or 68 ltr.



MSR 168

Single, 68 ltr waste container on mobile frame



Available container colors



white tan red

MSR 330

Triple 30 ltr waste container station

Top quality Gel-Cushions

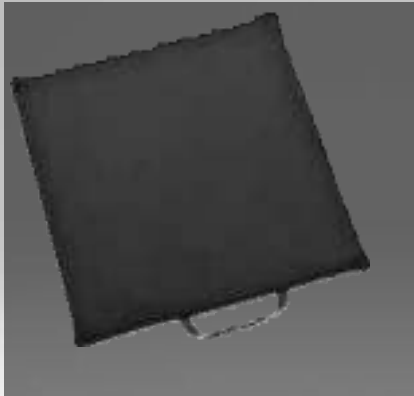

GKG
with pillowcase
43 x 43 x 2,5cm

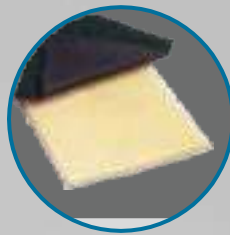

GKG 40
with pillowcase
40 x 40 x 2,5cm

The tried-and-tested Gel Cushions to provide advanced pressure management

These Gel Cushions are made with ELACTON® a high quality PU gel with outstanding elastic properties. It offers optimal pressure distribution and minimizes heat build-up. It is guaranteed not to leak and will serve its purpose for years.

- Guaranteed not to leak
- “Breathing” pillowcase, washable at 40° C
- Slip resistant coating on underside
- Supports up to 200kg



GKO
without pillowcase
43 x 43 x 2,5 cm

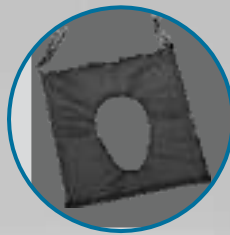

BEZGKO
Pillowcase
for GKO

The Gel Cushion with toilet opening. Comes standard without pillowcase, simply place it on toilet seat or use it on shower stool to alleviate pressure of hard surfaces. Cleans and disinfects easily.

- Guaranteed not to leak
- “Breathing” pillowcase, washable at 40° C
- Pillowcase with anti-glide
- Coating
- Supports up to 200 kg

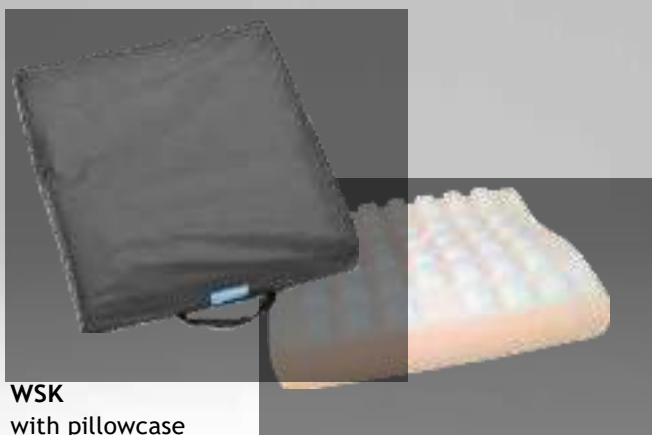

WSK
with pillowcase
43 x 43 x 6 cm

The combination of a 3D structure made of firm silicone and a firm foam cushion supporting it provides aeration and stimulants for excellent pressure distribution. The ergonomic design offers great thigh support.

- Guaranteed not to leak
- Pillowcase with slip-resistant coating,
- Washable at 40° C
- Supports up to 100 kg

We specialize in custom sizes!

Beach Mobil

The Beach Mobil SM 700

The chair that rolls easily over the most soft, sandy beaches thanks to its low pressure balloon tires and its sturdy RCN specific plastic structure.

All plastic components are UV resistant and extremely durable, offering safety and longevity.

Seat- and backrest cushion made with foam core and Textilene® fabric are comfortable for hours of beach enjoyment at the seaside where standard wheel chairs cannot go.

The Beach Mobil can be knocked down into three sections - no tools needed - making transport to and from the beach more amenable. The SM 700 comes standard with a tote bag. A hand operated brake/lock, a safety bar and a large parasol are optional.

This Beach Mobil lets wheel chair bound people enjoy the pleasures of a day on the beach!

- NO RUST, guaranteed
- Salt water resistant
- Ideal for sandy beaches and other uneven, and soft surfaces



	Total dimensions	Chassis	Chair
Length	110	110	74
Width	104	104	55
Height	111	45	85
Weight	35	10	12

All numbers in cm or kg.

Options:

- Brake/lock FBS
- Safety bar SBS
- Parasol with holder SO

All information subject to change without prior notice!



MRI compatible products - a specific challenge

MRI diagnostics are gaining an ever higher importance in healthcare. The industry is responding with more potent equipment and stronger magnetic fields. The ancillary equipment, chairs, stools, carts, gurneys etc. need to fulfill high safety standards and need to be easily discernible. RCN offers a broad range of MRI compatible products that respond exactly to these requirements.

Its specific features:

- Modular product design using only RCN specific plastic components and non-magnetic precious metal alloys
- All surfaces are skin friendly and very durable
- Very mobile due to high quality MRI compatible casters
- Modular manufacturing allows customizing at affordable costs

The MRI equipment from RCN fulfills all safety requirements for stations up to 3 Tesla. For these products we use only RCN specific plastic components together with non-magnetic metal alloys. For stations higher than 3 Tesla we offer customer specific product solutions, please contact us for special solutions and quotes.

RCN offers all plastic equipment - without any metal parts - for MRI stations with 7 Tesla.

We love to offer solutions for your specific needs, simply contact us!



TC 450 MRT

Standard with

- Swing-out armrests **2 ASA**
- PUR-foam padded armrests **AP**
- Safety-bar **SB**
- Push bar **GR**
- Slide-out, anti-tip footrest **FT**
- Soft seat **PUS** and soft backrest **PR** made of PUR-foam
- Ø100mm single wheel plastic/alloy casters - all locking



DR 100 MRT

- 24" self-propelled wheels with lock
- Swing-out armrests **2 ASA**
- Slide-out footrest **FT**
- Soft seat **PUS** and soft backrest **PR** made of PUR-foam

Product solutions for this environment

KTW 100 HS MRT

- Ø75 mm twin-wheel swivel casters (plastic/brass) - 2 locking
- 4 transparent drawers
- All plastic top plate
- Glove dispenser HSP
- Liquid dispenser ESP



HGW 100 MRT

- Ø75 mm twin-wheel swivel casters (plastic/brass) - 2 locking
- 3 transparent drawers
- All plastic top plate
- Glove dispenser HSP
- Liquid dispenser ESP



MPC 153 WS MRT

- Ø100 mm twin-wheel swivel casters (plastic/brass) - 2 locking
- 3 recessed shelves, removable
- Push-bar
- Wash basin WS



MPC 353 MRT

- 3 removable shelves, size 3
- Push-bar
- Ø100 mm twin-wheel swivel casters (plastic/brass) - 2 locking



Stepping stool, single- or double stage AT 1 MRT or AT 2 MRT

- No-slip strips and anti-slip feet
- Supports up to 150kg
- Height from 20 to 38 cm



DH 49 PA MRT

- Ergonomic seat
- Anti-slip feet
- Removable seat pad made of PUR-foam PA



IH MRT

Roll-along drip stand

- Ø75 mm twin-wheel swivel casters (plastic/brass) - 2 locking
- Supports up to 4 kg



Options:

- Pump holder PH
- Height adjustment HV



MS 120 MRT

- Waste collector, single, holds 15kg
- Bag holders, stainless steel
- Flip-up lid in various colors



MRI compatible products



DES 200

The special high chair for X-ray defecography examination and diagnosis of anorectal dysfunction and morphological changes. Having no materials blocking the X-rays ensures high precision pictures of the affected area. Oval pail included. Fitting stepping stools (single or double level) provide comfort and safety to the patient to reach seat heights of up and to 80 cm, these steps can be easily removed without tools.



TL 500 S MRT

Transfer Gurney with comfortable sling deck made of robust Textilene® fabric

- Drop-down side rails
- Ø 100 mm single-wheel swivel casters (plastic/brass)
 - all locking
- RCN specific plastic components, UV resistant and compatible with most disinfectants
- Light weight
- NO RUST
- Stable
- Supports up to 150 kg



TL 600 MRT

Multi-use Transfer Gurney with a comfortable deck pad with foam core and cover made of coated fabric

- Drop-down side rails
- Head/backrest adjusts to 7 positions
- Ø 100 mm single-wheel swivel casters (plastic/brass)
 - all locking
- RCN specific plastic components, UV resistant and compatible with most disinfectants
- Light weight
- NO RUST
- Stable
- Supports up to 150 kg

For color selection see pages 82 and 83

Product solutions - innovative ideas

PVGM 1

Privacy screen

- Height: 1,8m, width: 1,0m
- Ø 75 mm twin-wheel swivel casters - all locking - DLRGM
- Screen made of Sure-Chek® upon request also in Textilene® fabric

PVGM 2

Privacy screen like PVGM 1, but

- Height: 1,8 m , width: 1,8 m (not pictured)
- Screen made of Sure-Chek® upon request also in Textilene® fabric

PVEM

Privacy screen extension

- Height: 1,8 m, width: 1,0 m
- Ø 75 mm twin-wheel swivel casters - all locking - DLRGM
- Screen made of Sure-Chek® upon request also in Textilene® fabric

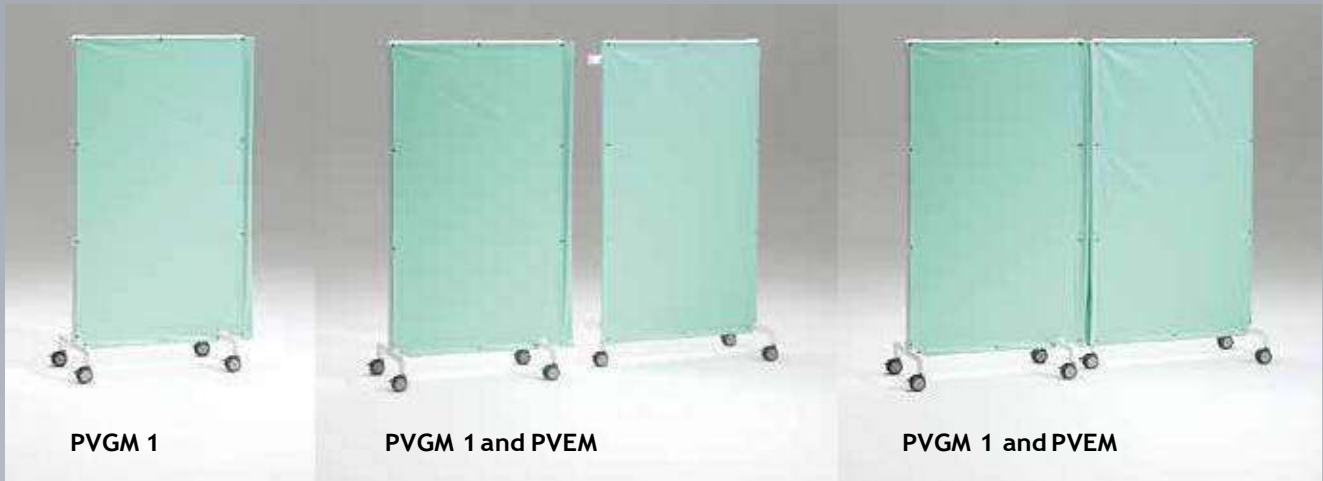

PVGM 1

PVGM 1 and PVEM

PVGM 1 and PVEM

For color selection see page 83

RPC 800

The extremely comfortable recliner with contoured seat and backrest cushions (only in blue) backrest and legrest can be individually adjusted for optimal positioning, swing-away and removable armrests as well as open design allow optimal access and cleanability. Tray that clips on to armrests is optional RSB

Exterior dimensions			Seat		
Depth	Width	Height	Depth	Width	Height
145	59	140	48	49	56

All measurements in cm

All information subject to change without prior notice!



The Easy Lift

RCN Easy Lift LS 2000

Serves as an easy means to lift patients that can still sit with bent knees out of one place and to transfer them in a safe position to another place. Especially patients with knee or hip contractions can be comfortably transferred to another place. Its small dimensions make it the ideal lift solution for tight places. Sturdy buttocks belt is easily adjusted on one side.

The ease of handling, the avoidance of patient anxiety and the safe and comfortable transport in any in-house area makes the LS 2000 a truly unique alternative to standard lift systems, especially for at home caregiving.

These features make the LS 2000 unique:

- Careful, anxiety-free pick up and transfer, safe through triple-point support (feet, knee and buttocks)
- Upper body and knees rest comfortably on PUR-foam supports and provide safety even to patients with reduced upper body control
- High quality twin-wheel swivel casters - 2 locking - offer great mobility and roll easily even over carpets and thresholds
- Best used for patients weighing up to 130 kg
- Mechanically operated - no battery charging - through easy going crank drive
- With an outside width of only 58 cm it passes through the narrowest doors
- Extremely low fork rolls easily under beds, wheelchairs, sofas, low chairs etc.
- Direct seating on toilet seat
- Handles easily, only 5 steps necessary
 1. Bring patient in to a sit-up position
 2. Approach patient with LS 2000 and place feet on footrest
 3. Place belt around and slightly underneath buttocks
 4. Lift patient by turning the easy going crank drive
 5. Place additional safety belt around back
- Always keep eye contact with patient
- TÜV tested

Guaranteed NO RUST!





Buttock belt



Crank drive



Footrest



Knee positioning



Upper body support



Ø100 mm twin-wheel swivel casters
- 2 locking

Exterior dimensions:
Length: 104,0 cm
Width: 58,0 cm
Height: 108,5 cm
Lifting range: 43,0 cm

Weight: 46,0 kg

Fork:
Clear width 24,5 cm
Outside width (in front): 35,0 cm
Outside width (front end footrest): 42,0 cm

Supports up to 130,0 kg

All information subject to change without prior notice!

Technical Data: Shower Stools

Model	Exterior dimensions			Seat			Capacity	Weight
	Depth	Width	Height	Depth	Width	Height		
DH 49	42	42	48	42	42	47	200	3,4
DH 49 A	42	53	63,5	42	42	47	150	5,5
DH 49 HV	42	42	41,5-56,5	42	42	40-55	150	5
DH 49 A RL	48	53	75	42	42	47	150	6,6
DH 49 PRS	55	43	79	42	42	47	150	6,9
DH 49 A PRS	53	54	92,5	42	42	47	150	9,6
DH 49 R	42	42	48	42	42	47	150	4*
DH 49 DLR	52	52	48,5	42	42	47	150	5,2

Attention: When ordered with option PA, seat height increases by 1,5cm

* Weight incl. bag

DH 80	51	54	68,5	50	44	51	150	7,1
DH 80 HV	51	54,5	67,5-82,5	50	44	50-65	150	7,9
DH 80 PP	52	54	68,5	52	44	53	150	8,3
DH 90	54,5	54	79,5	50	44	51	150	7,6
DH 90 PP PPE	54,5	54	79,5	50	44	53	150	10,5**
DH 100 PP	54,5	54,5	81,5	50	44	55	150	10,1
DT 100 HV	51	54,5	67,5-82,5	50	44	50-65	150	7,6
DT 100 HM SP	51	54,5	67,5-82,5	50	44	50-65***	150	8,8

** Incl. PPE (1,2 kg) *** Upper edge all plastic seat

SDH 70	51	45	91	20	39	65	120	8,4
DWH 86	48	57	61,5	34,5	43,5	51	120	6,7

Seat height can be adapted at no cost when requested with the order

DH 55 DS	40	40	50	40	40	50	300	6,7
DH 56	45	45	51	44,5	44	50	300	6,7
DT300 OSDSP	50	80	68,5****	50	70	51,5****	300	16,4
DH 80 OSDSP	50	66-70	68,5	50	56-60	51,5	250	14,2

All information in cm resp. kg

**** Fits over toilet of max 42 cm

3 year warranty, 5 year warranty on RCN specific plastic frame, aluminum or stainless steel frame!

PUR-foam for seat- and backrest cushions

Attention: Seats with weight capacity of 175 kg and higher are only available in blue.



graphite blue cobalt laguna

Coated fabric for seat- and backrest upholstery

Attention: Cushions made with this fabric should not be used in the shower.



saffron cherry sky pine charcoal

All information subject to change without prior notice!

Technical Data: Chairs

Model	Exterior dimensions			Seat			Lower leg length	Max seat clearance	Capacity	Weight
	Depth	Width	Height	Depth	Width	Height				
SCC 200	56	55,5	99	47,5	44	50	50	42	150	9,9
SCC 200 FT	56	55,5	102	47,5	44	53	41	45	150	11,9
SCC 200 BS FT	56,5	55,5	102	49	44	53,5	41,5	42	150	11,5
SCC 200 BS	56,5	55,5	99	49	44	50,5	50,5	39	150	9,3
SCC 200 S	56,5	55,5	108	49	44	53,5	41,5	42	150	12,5

SCC 250	60	55,5	99,5	46	44	50	50	42	150	9,7
SCC 250 HV SB	60,5	55,5	91,5-106,5	46	44	40-55	40-55	32-47	150	11
SCC 250 FT SB	60	55,5	104	46	44	53	41	45	150	11
SC 100 PUS	60	55,5	101	46	44	52,5	52,5	-	150	11
SCC 250 FT PR	58,5	55,5	105	46	44	53	41	45	150	15
SCC 250 D SB	60	55,5	104	46*	44	53**	41	45	150	16

* Without backrest cushion ** Upper edge all plastic seat

SCC 250 PS PR	58,5	55,5	101	45	44	52,5	52,5	42,5	150	11,5
SCC 250 PSG SB	58,5	55,5	105	45	44	55,5	43,5	45,5	150	18
SCC 250 PZG SB	58,5	55,5	105	45	44	55,5	43,5	45,5	150	17
SCC 250 PP PPE SB	60	55,5	101	46	44	52,5	52,5	42,5	150	13,5
SCC 250 PP FT	60	55,5	104	46	44	55,5	43,5	45,5	150	15
SCC 250 PPG SB AP ER	58,5	55,5	106,5	45	43	56,5	40,5	46,5	150	21,5
SCC 250 PPG SB	58,5	55,5	105	45	44	55,5	43,5	45,5	150	18
SCC 250 PPG SB 2ASA	58,5	55,5	105	45	44	55,5	43,5	45,5	150	20
SCC 250 PPG SB HV	59	55,5	97-107	45	44	48-58	36-46	38-48	150	18,5
SCC 250 PPG SB DRS	59	55,5	105	45	44	55,5	43,5	45,5	150	20

All information in cm resp. kg.

Colors for SCC 200:

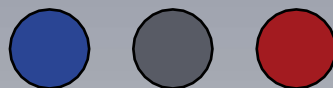

cobalt graphite red

Textilene® fabric "Sunsure" colors used for backrest supports



white navy blue suncastr blue wine-berry laguna yellow confetti

All information subject to change without prior notice!

Technical Data: Chairs

Model	Exterior dimensions			Seat			Lower leg length	Max seat clearance	Capacity	Weight
	Depth	Width	Height	Depth	Width	Height				
SCC 250 RC	100,5	55,5	135	43	44	59,5	-	-	150	33
KSC 180 FT RP SB	55,5	46	84-99	41,5*	35	37,5-52,5	25-40	-	150	12,5
SCC 250 R	55,5	55,5	81,5-89	47	44	47-54,5	47-54,5	39-46,5	150	12,3
SCC 250 KB	54,5	55,5/ 13**	96	49	44	51,5	51,5	43,5	150	9

All information in cm resp. kg

*Without backrest cushion

**Folded with toilet seat hanging down

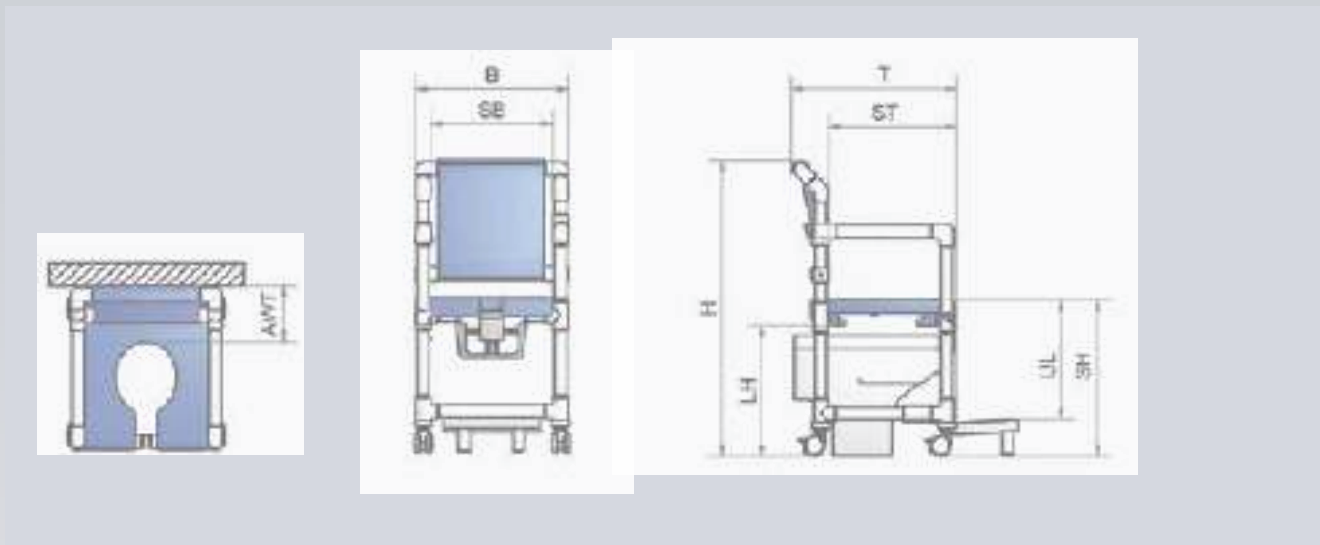

- T Exterior depth
- B Exterior width
- H Exterior height
- ST Seat depth
- SB Seat width
- SH Seat height
- UL Lower leg length
- LH Max. seat clearance
- AWT Distance from wall to seat opening

Seat height can be adapted at no cost when required with the order

Model	Distance from wall to seat opening AWT
SCC 200	19,5
SCC 200 BS	16
SCC 250 with Textilene® backrest and flat seat DS	24,5
SCC 250 with Textilene® backrest and Soft seats PP or PS	22,5
SCC 250 with soft backrest PR and all plastic toilet seat DS	22,5
SCC 250 with soft backrest PR and Soft seat PP or PS	20,5
SCC 250 with seat depth extension STE	29
SCC 250 OS 2 ASAOS	28
SCC 250 OS STE 2 ASAOS	35

All information subject to change without prior notice!

Technical Data: XXXL and Wheelchairs

Model	Exterior dimensions			Seat			Lower leg length	Max seat clearance	Capacity	Weight
	Depth	Width	Height	Depth	Width	Height				
SCC 250 OS DS	59	68-72	98,5	47	56-60	48	48	40	250	15,7
SCC 250 OS DS ASAOS PR	59	68-72	99,5	45	56-60	48	48	40	250	23
SCC 250 OS PPG	59	68-72	106	45,5	56-60	56,5	40	46,5	250	27,2
SCC 250 OS PPG STE	67	68-72	106	54	56-60	56,5	40	46,5	250	33
SCC 250 OS D	59	68-72	105,5	47	56-60	55*	38,5	47	250	25
SCC 250 OS DS ASAOS MFTOS	59	68-72	105,5	47	56-60	55*	38,5	47	250	20,9
SCC 250 OS PPG 2 ASAOS STE	67	68-72	106	54	56-60	56,5	40	46,5	250	36

* Upper edge all plastic toilet seat

SCC 250 XL DS	59	58-66	98,5	47	46-54	48	48	40	200	15
SCC 250 XL PPG	59	58-66	106	45	46-54	56,5	40	46,5	200	26
SCC 250 XL PPG PPE	59	58-66	106	45	46-54	56,5	40	46,5	200	27
SCC 250 XL PPG STE	67	58-66	106	54	46-54	56,5	40	46,5	200	31

SCC 250 XXXL 300 kg	73,5	82	106	54	70	55	38,5	-	300	38
SCC 250 XXXL 400 kg	73,5	92	106	54	80	55	38,5	-	400	46

HS 400 XXL	65	80	94	55	62	51	51	-	300	19
------------	----	----	----	----	----	----	----	---	-----	----

DR 100 PPG	80	72,5	101	45	44	56,5	40	46	150	26
DR 400	80	72,5	106	40	44	55	40	-	150	29
DR 250 XL PPG	79	74-82	101	45	46-54	54	37,5	-	175	34
DR 250 OS PPG	79	84-88	101	45	56-60	54	37,5	-	200	39

All information in cm resp. kg

Coated fabric for seat- and backrest upholstery

Attention: Cushions made with this fabric should NOT be used in the shower



PUR-foam for seat- and backrest cushions

Attention: Seats with weight capacity of 175 kg and higher come only in blue

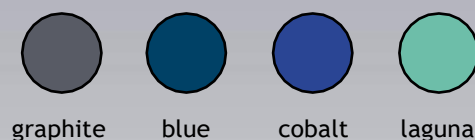

All information subject to change without prior notice!

Technical Data: Gurneys and RCN Walker

Model	Exterior dimensions			Seat			Lower leg length	Max seat clearance	Capacity	Weight
	Depth	Width	Height	Depth	Width	Height				
SCC 250 Comfort E	105	64	133	47	44	54,5	38-49	-	150	26,5

Model	Exterior dimensions			Deck			Capacity	Weight
	Depth	Width	Height	Up to body length	Up to shoulder width	Height		
UDL 1500	202	88	96	182	61	80	150	51
UDL 1500 DK	202	88	96	182	61	80	150	52
UDL 1500 VR	202	88	96	182	61	80	150	55
UDL 500	164	75	96	146	48	80	150	41
UDL 750	180	80	96	162	53	80	150	46

UDW 2500	200	79	70-110	185 / 200*	62	49-89	200	77
UDW 2500 VRW	200	79	70-110	185 / 200*	62	49-89	200	86
UDW 4500 XXL VRW	205	114	81-121	185 / 200*	95	52-92	400	150
UDW 650	177	71	70-110	162 / 177*	54	49-89	150	69

Please consider hall and door width when selecting a specific model

*With extended head rail

Model	Exterior dimensions			Seat			Height backrest	Capacity	Weight
	Depth	Width	Height	Depth	Width	Height			
GW 120	99,5	78,5	107-122,5	32,5	44,5	52-67,5	78,5-93,5	150	18
GW 120 AFS	102,5	81,5	107-122,5	32,5	44,5	52-67,5	78,5-93,5	150	19,5
GW 120 Mini	89	72	88,5-103,5	26	38,5	39-54	59,5-74,5	150	16
GW 120 Maxi	112,5	83,5	104-119	34	50	45-60	75-90	200	30,5
CW 300	105,5	78,5	115-130	-	-	-	102-117	150	20,5

All information in cm resp. kg

Coated fabric for seat cushions for GW 120 Maxi and Mini



Textilene® "Sunsure" colors for backrest and tote bag (see page 83)

PUR-foam for seat and backrest SCC 250 Comfort E, graphite



PUR-foam for soft seat of the GW 120

graphite

All information subject to change without prior notice!

Technical Data: Hampers and Carts

Model	Depth	Width	Height	Weight	Number of bags	Volume capacity
SLH 021 FP	50,5	40	100,5	9	1	1 x 120 / 35
SLH 023 FP	50,5	106,5	100,5	17	3	3 x 120 / 35
SLH 022	45	73,5	100,5	11	2	2 x 120 / 35
SLH 024 FP	50,5	141	100,5	20	4	4 x 120 / 35
SLH 023 B FP	100	73,5	100,5	16	3	3 x 120 / 25
SLH 024 B FP ESP 2 HSP ATS	103,5	84,5	122,5*	28	4	4 x 120 / 25
SLX 031 FPX	55,5	55,5	100	10	1	1 x 180 / 50
SLX 032 FPX	55,5	116	100	18	2	2 x 180 / 50

MS 120	45,5	40	91,5	5	1	1 x 120 / 20
MS 120 R	45,5	40	100,5	7	1	1 x 120 / 20
MS 240 FP R	50,5	73,5	100,5	12	2	2 x 120 / 20
MS 320 G	56	51	97	8	1	1 x 120 / 20

*Height without WSP: 100,5

Color stripes for bags WSW and WSWX

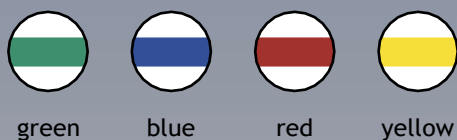

Color Sure-Chek® for leakproof bags

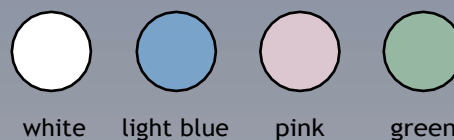

Lid colors to choose from:

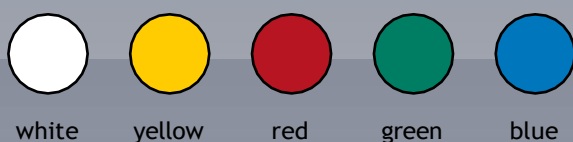

Model	Depth	Width	Height	Height without ESP	Height with ESP	Weight	Shelf distance	Usable shelf space	Shelf capacity
MC 231 S	51	108	140	106	140	24	35,5	41 x 33	30
MC 332 S SPL	52,5	155	138	103,5	138	37	32,5	60,5 x 50	35
MC 633 S	73,5	159,5	136,5	107	136,5	45	34,5	60,5 x 50	35
MC 642 FP ESP HSP	70,5	115,5	161	126	161	41	27,5	60,5 x 50	35

All information in cm resp. kg

Colors of Textilene® "Sunsure" fabric for covers and protective bags WSWX

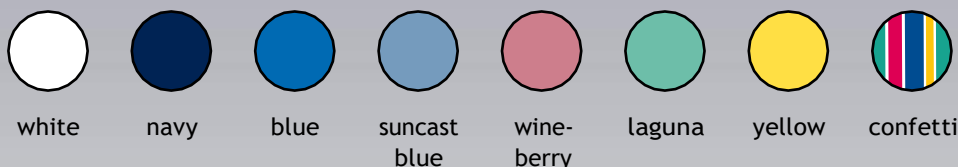

All information subject to change without prior notice!

Technical Data: Carts

Model	Depth	Width	Height	Height without ESP	Height with ESP	Weight	Shelf spacing	Usable shelf space	Recessed shelf space	Capacity per shelf
MPC 370 ESP HSP K3	52,5	68	147	120	147	45	10 / 20	55 x 41	42,5 x 36,5	45
MPC 370 ABH	52,5	94,5	120	120	147	45	29,5 / 31	55 x 41	52,5 x 43,5	50
MPC 372 S	52,5	154	147	120	147	49	29,5 / 31	55 x 41	52,5 x 43,5	50
MPC 360 ABW	52,5	91,5	114,5	114,5	147	43	29,5 / 31	55 x 41	47 x 43,5	50
MPC 370 ESP HSPPM	52,5	83	147	120	147	48	29,5 / 31	55 x 41	52,5 x 43,5	50
MPC 470	52,5	93	120	120	147	59	29,5 / 31,5	81 x 41	78 x 43,5	45
MPC 472 S	52,5	179	147	120	147	74	29,5 / 31,5	81 x 41	78 x 43,5	45
MPC 253 AS 50	52	67,5	109,5	109,5	136	16	21,5 / 31,5	60,5 x 50	-	35
MPC 153	44	52	109,5	109,5	136	10	32,5	41 x 33	-	30
MPC 253	52	67,5	109,5	109,5	136	13	31,5	60,5 x 50	-	35
MPC 353 ESP HSP	52	93	136	109,5	136	21	31,5	86 x 50	-	30

Model	Depth	Width	Height	Weight	Shelf spacing	Usable shelf space	Capacity per shelf
MLC 203	52	78,5	137	20	31,5	60,5 x 50 / Size 2	35
MLC 204	52	78,5	174	24	31,5	60,5 x 50 / Size 2	35
MLC 303	52	104	137	24	31,5	86 x 50 / Size 3	30
MLC 304	52	104	174	30	31,5	86 x 50 / Size 3	30
LC 503	51,5	141	164	31	45	106 x 39 / Size 5	40

Model	Depth	Width	Height	Weight	Length of Clothes rod	Number of boxes	Usable shelf space	Capacity per shelf	Size of boxes
GR 50	52	117	166,5	22	2 x 51	-	105,5 x 41	30	-
WT 424 KS	52	166	165	78	-	24	-	75	28,5 x 44 x 18,3
WB 312	52	142	164	41	39	12	39 x 50	30	28,5 x 44 x 18,3

All information in cm resp. kg

Colors of cabinet panels
MPC and MDC series



leafgreen



gentian
blue



signal
red



clementine
orange



broom
yellow



alabaster
white



white

All information subject to change without prior notice!

Model	Depth	Width	Height	Weight	Drawer Inside depth	Usable shelf space	
MDC 85 FB	55,5	52,5	106,5	28	45	41 x 33	
MDC 95	54,5	56	109,5	47	32,5	-	
MDC 100	63,5	57	106,5	54	53	-	

Model	Depth	Width	Height	Height without ESP	Höhe with ESP	Weight	Size of pull-out drawer D x W x H
KTW 100	38,5	41	85	85	122	9,5	2 x 35,5 x 24,5 x 7,5 2 x 35,5 x 24,5 x 17,5
KTW 100 HS	38,5	41	122	85,5	122	12	2 x 35,5 x 24,5 x 7,5 2 x 35,5 x 24,5 x 17,5
KTW 100 HS ATS ABH	38,5	71	122	85,5	122	18	2 x 35,5 x 24,5 x 7,5 2 x 35,5 x 24,5 x 17,5
KTW 100 HS ATS SPA	39	41	122	85,5	122	12,5	2 x 35,5 x 24,5 x 7,5 2 x 35,5 x 24,5 x 17,5
HGW 50	41	70	86	86	123	16	36 x 53 x 16,5
HGW 100 ATS	41	70	123	86,5	123	19	36 x 53 x 16,5
HGW 100 S	41	97,5	134	86,5	123	26	36 x 53 x 16,5
HGW 100 SPS	57	70	131	-	-	25	36 x 53 x 16,5
LTW 200	41	70	145,5	-	-	19	36 x 53 x 16,5

Model	Depth	Width	Height	Weight	Load capacity
MSR 168	41	45,5	76	9	1 x 68 Liter
MSR 330	41	149	52	16	3 x 30 Liter

All information in cm resp. kg

All information subject to change without prior notice!

Technical Data: MRI compatible products

Model	Exterior dimensions			Seat			Lower leg length	Capacity	Weight
	Depth	Width	Height	Depth	Width	Height			
TC 450 MRT	65	55	112,5	45	44	57	46	150	22
DR 100 MRT	79,5	72	107,5	45	44	57	40	150	32

Model	Depth	Width	Height	Height without ESP	Height with ESP	Weight	Size of pull-out drawer D x W x H
KTW 100 HS MRT	38,5	41	122	85,5	122	12	2 x 35,5 x 24,5 x 7,5 2 x 35,5 x 24,5 x 17,5
HGW 100 MRT	41	70	123	86,5	123	19	36 x 53 x 16,5

Model	Depth	Width	Height	Height without ESP	Height with ESP	Weight	Shelf distance	Usable shelf space	Capacity per shelf
MPC 153 WS MRT	44	52	107,5	107,5	136	10,5	32,5	41 x 33	30
MPC 353 MRT	50,5	93	107,5	107,5	136	19	31,5	86 x 50	30

Model	Depth	Width	Height	Weight	Capacity
Step AT 1	35	40	20	3	150
Steps AT 2	66	40	20/38	7,5	150

Model	Exterior dimensions			Seat			Weight	Capacity
	Depth	Width	Height	Depth	Width	Height		
DH 49 PA MRT	42	42	49	42	42	48	4,7	200

Model	Depth	Width	Height	Weight
IH MRT	66	66	187,5	5

Model	Depth	Width	Height	Weight	Number of bags	Volume capacity
MS 120 MRT	45,5	40	91,5	5	1	1 x 120 / 20

Model	Depth	Width	Height	Weight	Seat height
DES 200	121	45	100,5	22	80

Model	Exterior dimensions			Deck			Capacity	Weight
	Length	Width	Height	up to body length	Up to shoulder width	Height		
TL 500 S MRT	197	82	87,5	186	59,5	76,5	150	28
TL 600 MRT	201	76	96	190	63	77	150	48

All information in cm resp. kg

All information subject to change without prior notice!

Medimpex Care Solutions

Faradaystraat 14-01, 4004 JZ Tiel

0344-615300

info@medimpex.nl

www.medimpex.nl



RCN - the best address for Healthcare Equipment, Quality and Service!

RCN Medizin- und Rehattechnik GmbH

Hauptstraße 4 · D-55471 Sargenroth · Tel. +49 (0) 6761-9197-0

Fax +49 (0) 6761-9197-70 · info@rcn-medizin.de

www.rcn-medizin.com

